

**FLUOROMONOMERS
MANUFACTURING PROCESS
DIVISION STACK AND BLOWER INTAKE
EMISSIONS TEST REPORT
TEST DATES: 26-28 FEBRUARY, 1 MARCH 2019**

**THE CHEMOURS COMPANY
FAYETTEVILLE, NORTH CAROLINA**

Prepared for:



THE CHEMOURS COMPANY
22828 NC Hwy 87 W
Fayetteville, North Carolina 28306

Prepared by:



WESTON SOLUTIONS, INC.
1400 Weston Way
P.O. Box 2653
West Chester, Pennsylvania 19380

April 2019

W.O. No. 15418.002.010

TABLE OF CONTENTS

Section	Page
1. INTRODUCTION.....	1
1.1 FACILITY AND BACKGROUND INFORMATION	1
1.2 TEST OBJECTIVES	1
1.3 TEST PROGRAM OVERVIEW	1
2. SUMMARY OF TEST RESULTS	3
3. PROCESS DESCRIPTIONS	5
3.1 FLUOROMONOMERS	5
3.2 PROCESS OPERATIONS AND PARAMETERS	5
4. DESCRIPTION OF TEST LOCATIONS.....	7
4.1 DIVISION STACK.....	7
4.2 BLOWER INTAKE.....	9
5. SAMPLING AND ANALYTICAL METHODS.....	11
5.1 STACK GAS SAMPLING PROCEDURES	11
5.1.1 Pre-Test Determinations	11
5.2 STACK PARAMETERS	11
5.2.1 EPA Method 0010.....	11
5.2.2 EPA Method 0010 Sample Recovery	14
5.2.3 EPA Method 0010 Sample Analysis.....	17
5.3 GAS COMPOSITION	18
6. DETAILED TEST RESULTS AND DISCUSSION	20
APPENDIX A PROCESS OPERATIONS DATA	
APPENDIX B RAW AND REDUCED TEST DATA	
APPENDIX C LABORATORY ANALYTICAL REPORT	
APPENDIX D SAMPLE CALCULATIONS	
APPENDIX E EQUIPMENT CALIBRATION RECORDS	
APPENDIX F LIST OF PROJECT PARTICIPANTS	

LIST OF FIGURES

Title	Page
Figure 4-1 Division Stack Test Port and Traverse Point Location	8
Figure 4-2 Blower Intake Sampling Location	10
Figure 5-1 EPA Method 0010 Sampling Train.....	13
Figure 5-2 HFPO Dimer Acid Sample Recovery Procedures for Method 0010	16
Figure 5-3 WESTON Sampling System	19

LIST OF TABLES

Title	Page
Table 1-1 Sampling Plan for Division Stack and Blower Intake Testing.....	2
Table 2-1 Summary of Division Stack HFPO Dimer Acid Test Results.....	3
Table 2-2 Summary of Division Stack and Blower Intake HFPO Dimer Acid Test Results	4
Table 3-1 Test Campaign Process Conditions	6
Table 6-1 Summary of HFPO Dimer Acid Test Data and Test Results Division Stack – Runs 1-8	21
Table 6-2 Summary of HFPO Dimer Acid Test Data and Test Results Blower Intake – Runs 1-8	23

1. INTRODUCTION

1.1 FACILITY AND BACKGROUND INFORMATION

The Chemours Fayetteville Works (Chemours) is located in Bladen County, North Carolina, approximately 10 miles south of the city of Fayetteville. Chemours operating areas on the site include the Fluoromonomers, IXM and Polymers Processing Aid (PPA) manufacturing areas, Wastewater Treatment, and Powerhouse.

Chemours contracted Weston Solutions, Inc. (Weston) to perform HFPO Dimer Acid Fluoride, captured as HFPO Dimer Acid, emission testing on the Division Stack at the facility. Simultaneously, ambient air sampling was conducted at the Blower Intake. Testing was performed on 26-28 February and 1 March 2019 and generally followed the “Emission Test Protocol” reviewed and approved by the North Carolina Department of Environmental Quality (NCDEQ). This report provides the results from the emission test program.

1.2 TEST OBJECTIVES

The specific objectives for this test program were as follows:

- Measure the emissions concentrations and mass emissions rates of HFPO Dimer Acid Fluoride from the Division stack which is located in the Fluoromonomers process area.
- Measure the ambient air concentration of HFPO Dimer Acid Fluoride at the Blower Intake which supplies room air to the Fluoromonomers process building.
- Monitor and record process and emissions control data in conjunction with the test program.
- Provide representative emissions data.

1.3 TEST PROGRAM OVERVIEW

During the emissions test program, the concentrations and mass emissions rates of HFPO Dimer Acid were measured at two locations.

Table 1-1 provides a summary of the test locations and the parameters that were measured along with the sampling/analytical procedures that were followed.

Section 2 provides a summary of test results. A description of the processes is provided in Section 3. Section 4 provides a description of the test location. The sampling and analytical procedures are provided in Section 5. Detailed test results and discussion are provided in Section 6.

Appendix C includes the summary reports for the laboratory analytical results. The full laboratory data package is provided in electronic format and on CD with each hard copy.

**Table 1-1
Sampling Plan for Division Stack and Blower Intake Testing**

Sampling Point & Location	Division Stack and Blower Intake				
Number of Tests:	16 (8 Division Stack, 8 Blower Intake)				
Parameters To Be Tested:	HFPO Dimer Acid (HFPO-DA)	Volumetric Flow Rate and Gas Velocity	Carbon Dioxide	Oxygen	Water Content
Sampling or Monitoring Method	EPA M-0010	EPA M1, M2, M3A, and M4 in conjunction with M-0010 tests	EPA M3/3A		EPA M4 in conjunction with M-0010 tests
Sample Extraction/ Analysis Method(s):	LC/MS/MS	NA ⁶	NA		NA
Sample Size	≥ 1.5m ³	NA	NA	NA	NA
Total Number of Samples Collected ¹	16	8	8	8	8
Reagent Blanks (Solvents, Resins) ¹	1 set	0	0	0	0
Field Blank Trains ¹	0 per source	0	0	0	0
Proof Blanks ¹	1 per train	0	0	0	0
Trip Blanks ^{1,2}	1 set	0	0	0	
Lab Blanks	1 per fraction ³	0	0	0	0
Laboratory or Batch Control Spike Samples (LCS)	1 per fraction ³	0	0	0	0
Laboratory or Batch Control Spike Sample Duplicate (LCSD)	1 per fraction ³	0	0	0	0
Media Blanks	1 set ⁴	0	0	0	0
Isotope Dilution Internal Standard Spikes	Each sample	0	0	0	0
Total No. of Samples	20 ⁵	8	8	8	8

Key:

¹ Sample collected in field.

² Trip blanks include one XAD-2 resin module and one methanol sample per sample shipment.

³ Lab blank and LCS/LCSD includes one set per analytical fraction (front half, back half and condensate).

⁴ One set of media blank archived at laboratory at media preparation.

⁵ Actual number of samples collected in field.

⁶ Not applicable.

2. SUMMARY OF TEST RESULTS

A total of eight test runs each were performed on the Division Stack and Blower Intake. Table 2-1 provides a summary of the HFPO Dimer Acid emissions test results. The Blower Intake sample location only measured the HFPO Dimer Acid concentrations of ambient air entering the blower. Table 2-2 provides a comparison of the HFPO Dimer Acid concentrations at the Blower Intake and the Division Stack. Detailed test results summaries are provided in Section 6.

It is important to note that emphasis is being placed on the characterization of the emissions based on the stack test results. Research conducted in developing the protocol for stack testing HFPO Dimer Acid Fluoride, HFPO Dimer Acid Ammonium Salt and HFPO Dimer Acid realized that the resulting testing, including collection of the air samples and extraction of the various fraction of the sampling train, would result in all three compounds being expressed as simply the HFPO Dimer Acid. However, it should be understood that the total HFPO Dimer Acid results provided on Table 2-1 and 2-2, and in this report, include a percentage of each of the three compounds.

**Table 2-1
Summary of Division Stack HFPO Dimer Acid Test Results**

Source	Run No.	Emission Rates	
		g/sec	lb/hr
Division Stack	1	1.47E-02	1.17E-01
	2	1.96E-03	1.56E-02
	3	1.36E-03	1.08E-02
	4	1.51E-02	1.20E-01
	5	1.91E-02	1.51E-01
	6	5.30E-03	4.21E-02
	7	1.32E-02	1.05E-01
	8	2.20E-03	1.75E-02
	Average	9.12E-03	7.24E-02

Table 2-2
Summary of Division Stack and Blower Intake HFPO Dimer Acid Test Results

Run No.	Division Stack	Blower Intake
	lb/dscf	lb/dscf
1	6.87E-08	1.55E-11
2	9.22E-09	7.66E-12
3	6.41E-09	1.31E-11
4	7.06E-08	1.07E-11
5	8.87E-08	1.22E-11
6	2.44E-08	5.79E-11
7	6.01E-08	1.41E-11
8	1.00E-08	6.17E-12
Average	4.23E-08	1.72E-11

3. PROCESS DESCRIPTIONS

The Fluoromonomers area is included in the scope of this test program.

3.1 FLUOROMONOMERS

These facilities produce a family of fluorocarbon compounds used to produce Chemours products such as Nafion®, Krytox®, and Viton®, as well as sales to outside customers.

Process emissions are vented to the Division waste gas scrubber system (which includes the secondary scrubber) and vents to the Carbon Bed and then onto the Division Stack.

The Blower Intake is located on the rooftop of the Fluoromonomers Process building and provides room air to the building's HVAC system.

The VE North building air systems are also vented to the Carbon Bed and connected to the Tower Exhaust Blower.

3.2 PROCESS OPERATIONS AND PARAMETERS

The following table is a summary of the operation and products from the specific areas tested.

Source	Operation/Product	Batch or Continuous
Division	PPVE	Condensation is a continuous. Agitated Bed Reactor and Refining are batch.

During the test program, the following parameters were monitored by Chemours and are included in Appendix A.

- Fluoromonomers Process
 - VEN Precursor Rate
 - VEN Condensation Rate
 - VEN ABR Rate

The following table provides a summary of the process conditions established for each of the eight test runs:

**Table 3-1
Test Campaign Process Conditions**

Run No.	Date	ABR
1	2/26/19	Feeding
2	2/26/19	Burnout
3	2/27/19	Off
4	2/27/19	Feeding
5	2/28/19	Feeding
6	2/28/19	Burnout
7	3/1/19	Feeding
8	3/1/19	Burnout

4. DESCRIPTION OF TEST LOCATIONS

4.1 DIVISION STACK

Two 6-inch ID test ports were installed on the 36-inch ID fiberglass stack as shown below. The four vents that enter the top of the stack and the one vent ~11 feet below are catch pots which, under normal process operations, do not discharge to the stack. They are used to vent process gas to the stack in the event of a process upset and are not considered a flow contributor or a disturbance.

Per EPA Method 1, a total of 12 traverse points (six per axis) were used for M-0010 isokinetic sampling. Figure 4-1 provides a schematic of the test ports and traverse point locations.

Location	Distance from Flow Disturbance	
	Downstream (B)	Upstream (A)
Division Stack	30 feet > 10 duct diameters	9 feet > 3 diameters

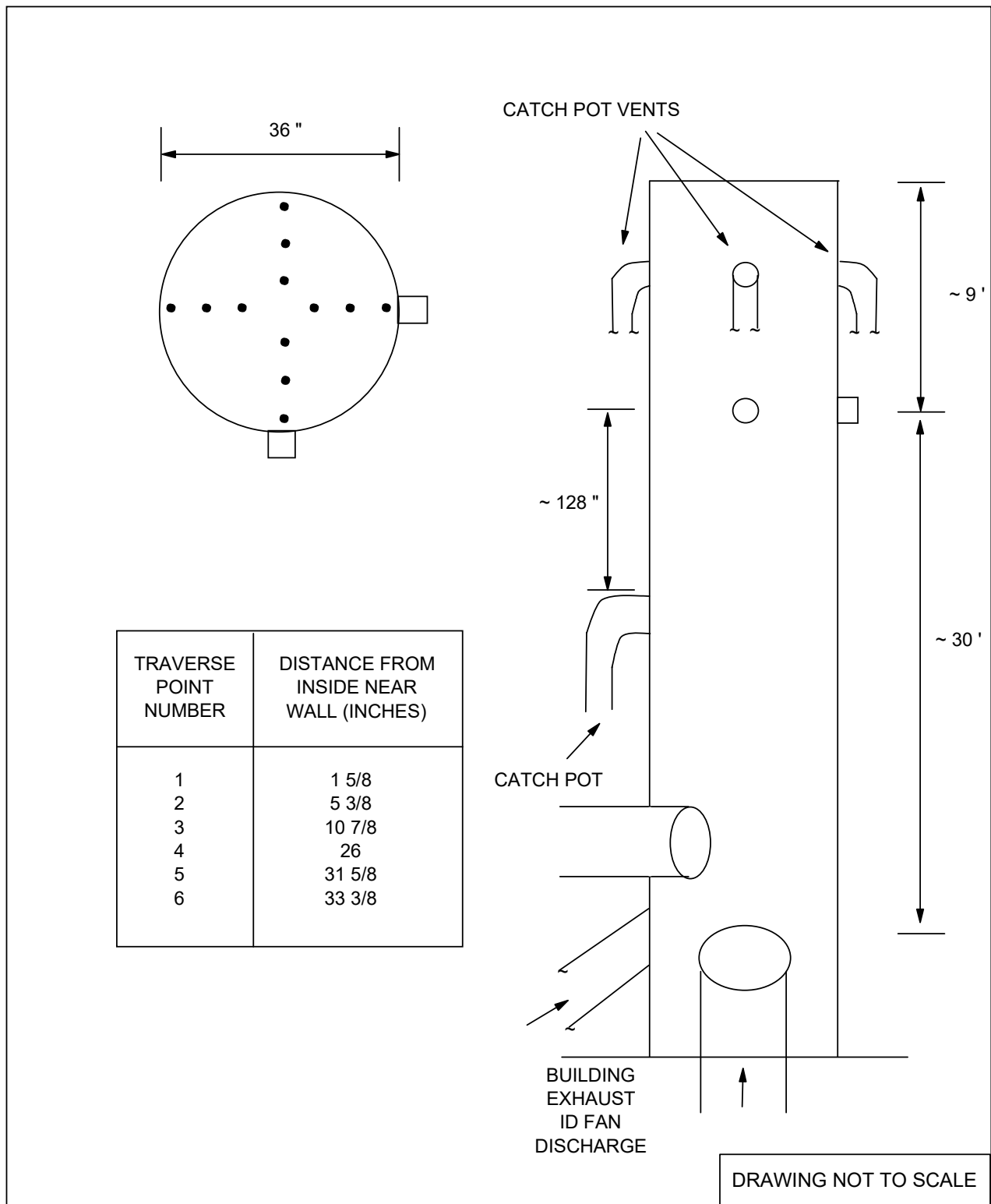

**FIGURE 4-1
DIVISION STACK TEST PORT
AND TRAVERSE POINT LOCATIONS**

4.2 BLOWER INTAKE

The Blower Intake is shown in Figure 4-2. Several air filters are located inside of the metal housing prior to the blower. The underside of the Blower Intake housing is open to allow the free flow of air into the system. The Method 0010 sample train probe was located below the metal housing and close to the inlet of the air filters.



Figure 4-2
Blower Intake Sampling Location

5. SAMPLING AND ANALYTICAL METHODS

5.1 STACK GAS SAMPLING PROCEDURES

The purpose of this section is to describe the stack gas emissions sampling trains and to provide details of the stack sampling and analytical procedures utilized during the emissions test program.

The sample train used at the Blower Intake location was the same configuration as the standard Method 0010 described below. However, the sample train was only positioned at a single location below the Blower Intake air filters, was not moved during the test, and was sampled at a constant rate.

5.1.1 Pre-Test Determinations

Preliminary test data were obtained at each test location. Stack geometry measurements were measured and recorded, and traverse point distances verified. A preliminary velocity traverse was performed utilizing a calibrated S-type pitot tube and an inclined manometer to determine velocity profiles. Flue gas temperatures were observed with a calibrated direct readout panel meter equipped with a chromel-alumel thermocouple. Preliminary water vapor content was estimated by wet bulb/dry bulb temperature measurements.

A check for the presence or absence of cyclonic flow was previously conducted at the test location. The cyclonic flow checks were negative ($< 20^\circ$) verifying that the test location was acceptable for testing.

Preliminary test data was used for nozzle sizing and sampling rate determinations for isokinetic sampling procedures.

Calibration of probe nozzles, pitot tubes, metering systems, and temperature measurement devices was performed as specified in Section 5 of EPA Method 5 test procedures.

5.2 STACK PARAMETERS

5.2.1 EPA Method 0010

The sampling train utilized to perform the HFPO Dimer Acid sampling at the outlet location was an EPA Method 0010 train (see Figure 5-1). The Method 0010 consisted of a borosilicate nozzle

that attached directly to a heated borosilicate probe. In order to minimize possible thermal degradation of the HFPO Dimer Acid, the probe and particulate filter were heated above stack temperature to minimize water vapor condensation before the filter. The probe was connected directly to a heated borosilicate filter holder containing a solvent extracted glass fiber filter.

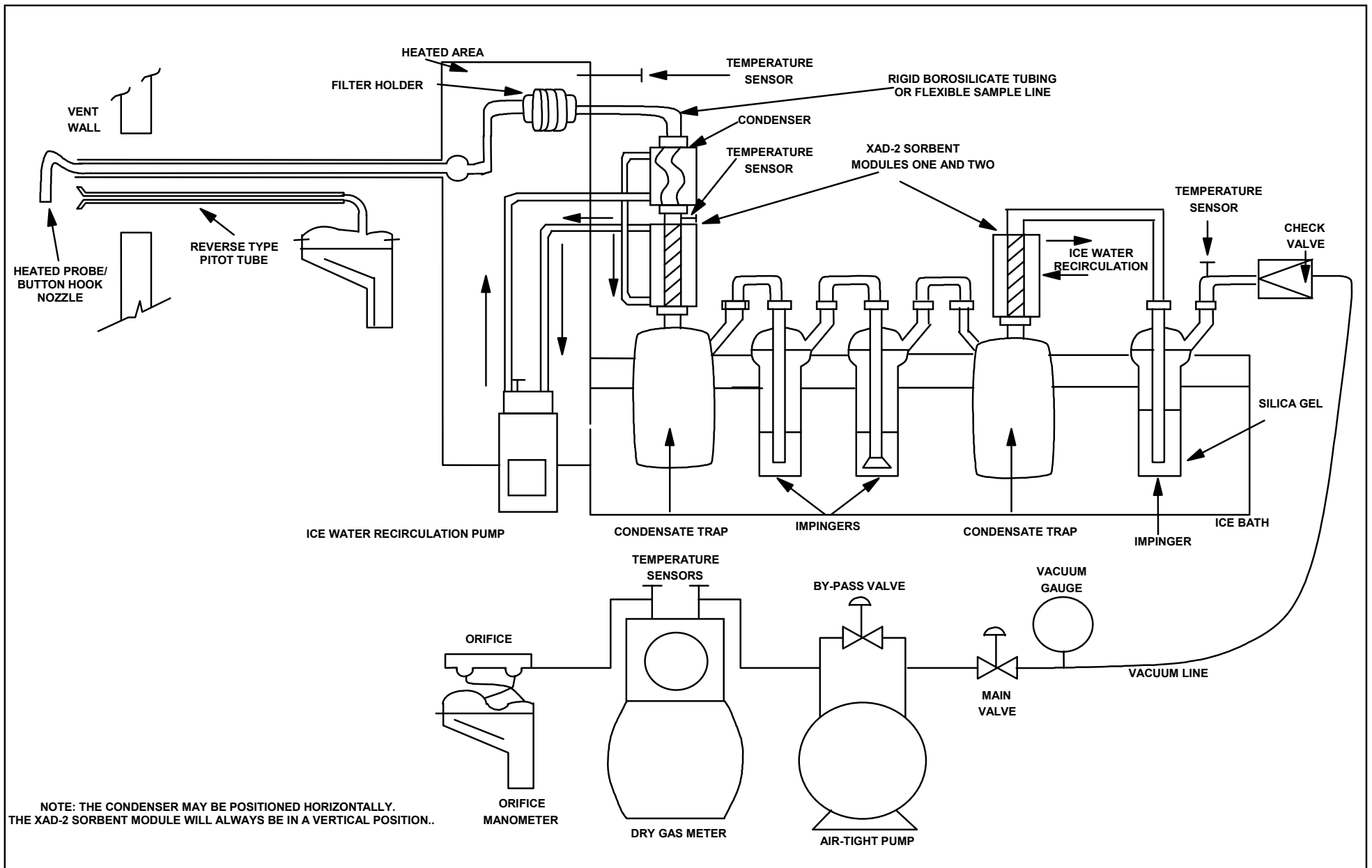

**FIGURE 5-1
EPA METHOD 0010 SAMPLING TRAIN**

A section of borosilicate glass or flexible polyethylene tubing connected the filter holder exit to a Graham (spiral) type ice water-cooled condenser, an ice water-jacketed sorbent module containing approximately 40 g of XAD-2 resin. The XAD-2 resin tube was equipped with an inlet temperature sensor. The XAD-2 resin trap was followed by a condensate knockout impinger and a series of two impingers that contained 100 mL of high purity distilled water. The train also included a second XAD-2 resin trap behind the impinger section to evaluate possible sampling train breakthrough. Each XAD-2 resin trap was connected to a 1-liter condensate knockout trap. The final impinger contained 300 grams of dry pre-weighed silica gel. All impingers and the condensate traps were maintained in an ice bath. Ice water was continuously circulated in the condenser and both XAD-2 modules to maintain method-required temperature. A control console with a leakless vacuum pump, a calibrated orifice, and dual inclined manometers was connected to the final impinger via an umbilical cord to complete the sample train.

HFPO Dimer Acid Fluoride (CAS No. 2062-98-8) that is present in the stack gas is expected to be captured in the sampling train along with HFPO Dimer Acid (CAS No. 13252-13-6). HFPO Dimer Acid Fluoride underwent hydrolysis instantaneously in water in the sampling train and during the sample recovery step, and was converted to HFPO Dimer Acid such that the amount of HFPO Dimer Acid emissions represented a combination of both HFPO Dimer Acid Fluoride and HFPO Dimer Acid.

During sampling, gas stream velocities were measured by attaching a calibrated S-type pitot tube into the gas stream adjacent to the sampling nozzle. The velocity pressure differential was observed immediately after positioning the nozzle at each traverse point, and the sampling rate adjusted to maintain isokineticity at $100\% \pm 10$. Flue gas temperature was monitored at each point with a calibrated panel meter and thermocouple. Isokinetic test data was recorded at each traverse point during all test periods, as appropriate. Leak checks were performed on the sampling apparatus according to reference method instructions, prior to and following each run, component change (if required) or during midpoint port changes.

5.2.2 EPA Method 0010 Sample Recovery

At the conclusion of each test, the sampling train was dismantled, the openings sealed, and the components transported to the field laboratory trailer for recovery.

A consistent procedure was employed for sample recovery:

1. The two XAD-2 covered (to minimize light degradation) sorbent modules (1 and 2) were sealed and labeled.
2. The glass fiber filter(s) were removed from the holder with tweezers and placed in a polyethylene container along with any loose particulate and filter fragments.
3. The particulate adhering to the internal surfaces of the nozzle, probe and front half of the filter holder were rinsed with a solution of methanol and ammonium hydroxide into a polyethylene container while brushing a minimum of three times until no visible particulate remains. Particulate adhering to the brush was rinsed with methanol/ammonium hydroxide into the same container. The container was sealed.
4. The volume of liquid collected in the first condensate trap was measured, the value recorded, and the contents poured into a polyethylene container.
5. All train components between the filter exit and the first condensate trap were rinsed with methanol/ammonium hydroxide. The solvent rinse was placed in a separate polyethylene container and sealed.
6. The volume of liquid in impingers one and two, and the second condensate trap, were measured, the values recorded, and the sample was placed in the same container as Step 4 above, then sealed.
7. The two impingers, condensate trap, and connectors were rinsed with methanol/ammonium hydroxide. The solvent sample was placed in a separate polyethylene container and sealed.
8. The silica gel in the final impinger was weighed and the weight gain value recorded.
9. Site (reagent) blank samples of the methanol/ammonium hydroxide, XAD resin, filter and distilled water were retained for analysis.

Each container was labeled to clearly identify its contents. The height of the fluid level was marked on the container of each liquid sample to provide a reference point for a leakage check during transport. All samples were maintained cool.

See Figure 5-2 for a schematic of the Method 0010 sample recovery process.

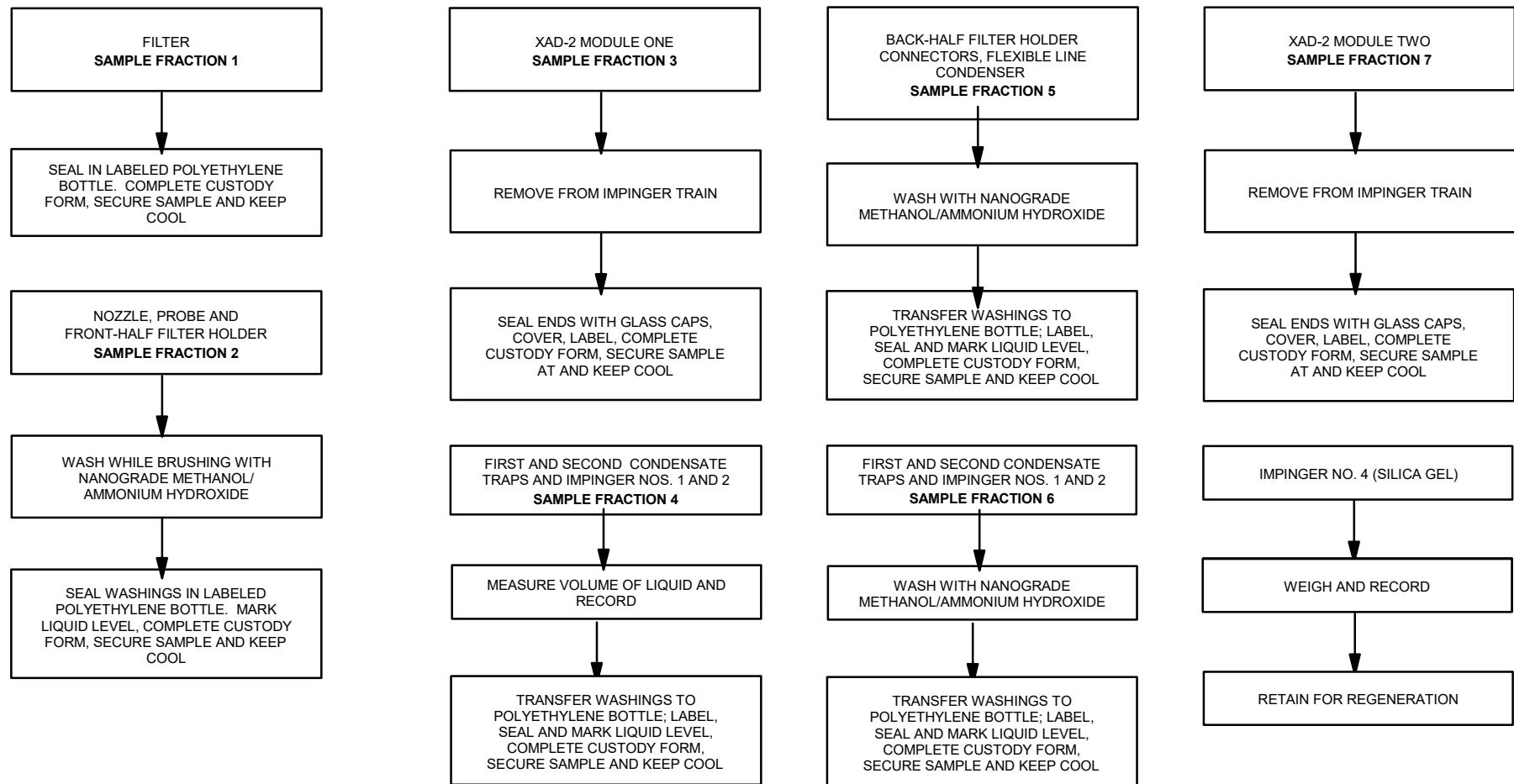

FIGURE 5-2
HFPO DIMER ACID SAMPLE RECOVERY PROCEDURES FOR METHOD 0010

5.2.3 EPA Method 0010 Sample Analysis

Method 0010 sampling trains resulted in four separate analytical fractions for HFPO Dimer Acid analysis according to SW-846 Method 3542:

- Front-half Composite—comprised of the particulate filter, and the probe, nozzle, and front-half of the filter holder solvent rinses;
- Back-half Composite—comprised of the first XAD-2 resin material and the back-half of the filter holder with connecting glassware solvent rinses;
- Condensate Composite—comprised of the aqueous condensates and the contents of impingers one and two with solvent rinses;
- Breakthrough XAD-2 Resin Tube—comprised of the resin tube behind the series of impingers.

The second XAD-2 resin material was analyzed separately to evaluate any possible sampling train HFPO-DA breakthrough.

The front-half and back-half composites and the second XAD-2 resin material were placed in polypropylene wide-mouth bottles and tumbled with methanol containing 5% NH₄OH for 18 hours. Portions of the extracts were processed analytically for the HFPO dimer acid by liquid chromatography and dual mass spectroscopy (HPLC/MS/MS). The condensate composite was concentrated onto a solid phase extraction (SPE) cartridge followed by desorption from the cartridge using methanol. Portions of those extracts were also processed analytically by HPLC/MS/MS.

Samples were spiked with isotope dilution internal standard (IDA) at the commencement of their preparation to provide accurate assessments of the analytical recoveries. Final data was corrected for IDA standard recoveries.

TestAmerica developed detailed procedures for the sample extraction and analysis for HFPO Dimer Acid. These procedures were incorporated into the test protocol.

5.3 GAS COMPOSITION

The Weston mobile laboratory equipped with instrumental analyzers was used to measure carbon dioxide (CO₂) and oxygen (O₂) concentrations. A diagram of the Weston sampling system is presented in Figure 5-3.

The sample was collected at the exhaust of the Method 0010 sampling system. At the end of the line, a tee permitted the introduction of calibration gas. The sample was drawn through a heated Teflon® sample line to the sample conditioner. The output from the sampling system was recorded electronically, and one minute averages were recorded and displayed on a data logger.

Each analyzer was set up and calibrated internally by introduction of calibration gas standards directly to the analyzer from a calibration manifold. The calibration manifold is designed with an atmospheric vent to release excess calibration gas and maintained the calibration at ambient pressure. The direct calibration sequence consisted of alternate injections of zero and mid-range gases with appropriate adjustments until the desired responses were obtained. The high-range standards were then introduced in sequence without further adjustment.

The sample line integrity was verified by performing a bias test before and after each test period. The sampling system bias test consisted of introducing the zero gas and one up-range calibration standard in excess to the valve at the probe end when the system was sampling normally. The excess calibration gas flowed out through the probe to maintain ambient sampling system pressure. Calibration gas supply was regulated to maintain constant sampling rate and pressure. Instrument bias check response was compared to internal calibration responses to insure sample line integrity and to calculate a bias correction factor after each run using the ratio of the measured concentration of the bias gas certified by the calibration gas supplier.

The oxygen and carbon dioxide content of each stack gas was measured according to EPA Method 3A procedures which incorporate the latest updates of EPA Method 7E. A Servomex Model 4900 analyzer (or equivalent) was used to measure oxygen content. A Servomex Model 4900 analyzer (or equivalent) was used to measure carbon dioxide content of the stack gas. Both analyzers were calibrated with EPA Protocol gases prior to the start of the test program and performance was verified by sample bias checks before and after each test run.

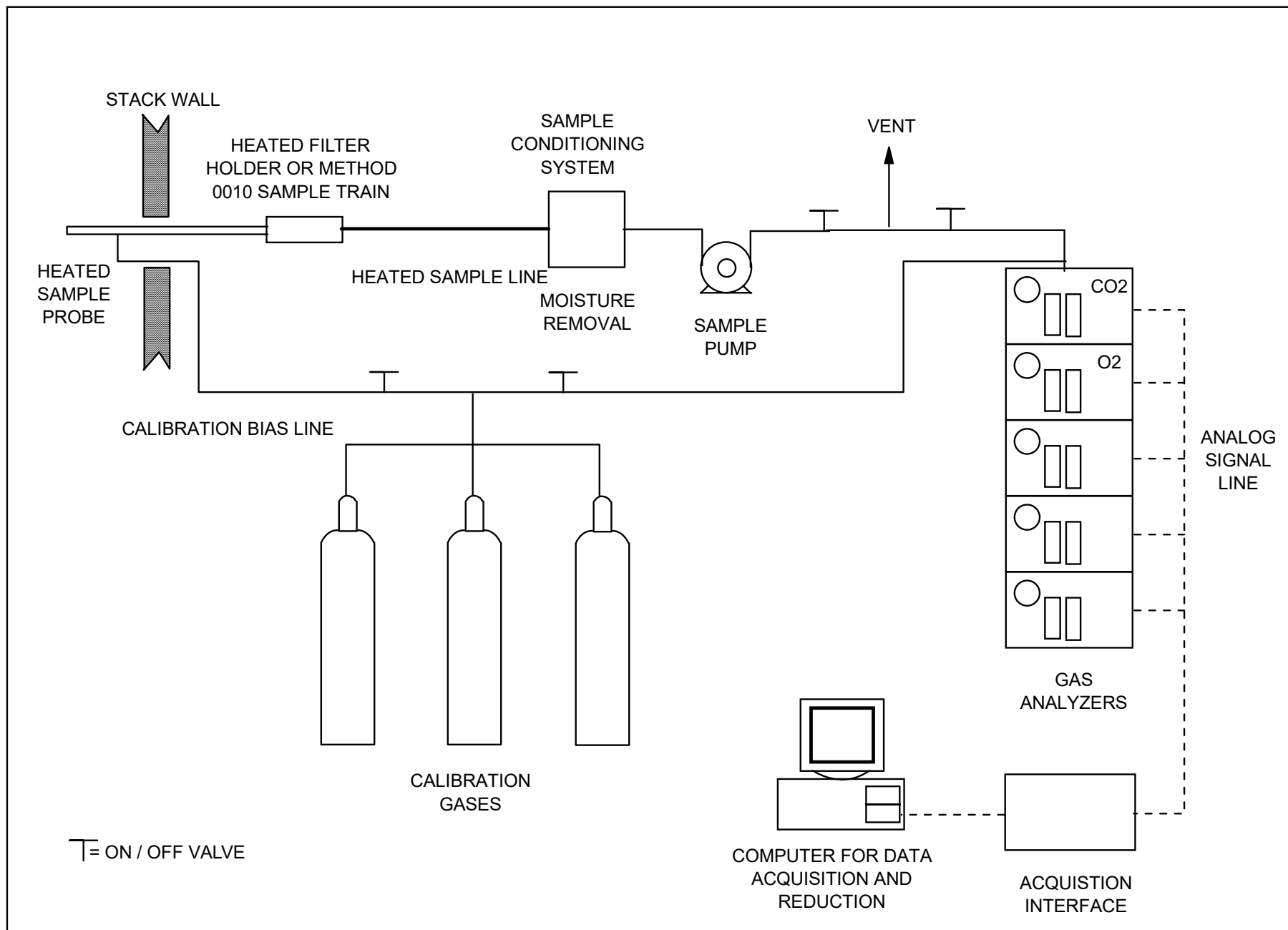

FIGURE 5-3
WESTON SAMPLING SYSTEM

6. DETAILED TEST RESULTS AND DISCUSSION

Each test was a minimum of 96 minutes in duration. A total of eight test runs were performed at each location.

Tables 6-1 and 6-2 provide detailed test data and test results for the Division stack and Blower Intake, respectively.

The Method 3A sampling indicated that the O₂ and CO₂ concentrations were at ambient air levels (20.9% O₂, 0% CO₂), therefore, 20.9% O₂ and 0% CO₂ values were used in all calculations.

TABLE 6-1
CHEMOURS - FAYETTEVILLE, NC
SUMMARY OF HFPO DIMER ACID TEST DATA AND TEST RESULTS
DIVISION STACK

Test Data

	1	2	3
Run number			
Location	Divison Stack	Divison Stack	Divison Stack
Date	2/26/19	2/26/19	2/27/19
Time period	0927-1143	1335-1530	0840-1035

SAMPLING DATA:

Sampling duration, min.	96.0	96.0	96.0
Nozzle diameter, in.	0.160	0.160	0.160
Cross sectional nozzle area, sq.ft.	0.000140	0.000140	0.000140
Barometric pressure, in. Hg	30.19	30.10	30.12
Avg. orifice press. diff., in H ₂ O	1.05	1.04	1.01
Avg. dry gas meter temp., deg F	68.7	74.3	54.8
Avg. abs. dry gas meter temp., deg. R	529	534	515
Total liquid collected by train, ml	25.2	20.2	18.7
Std. vol. of H ₂ O vapor coll., cu.ft.	1.2	1.0	0.9
Dry gas meter calibration factor	1.0069	1.0069	1.0069
Sample vol. at meter cond., dcf	52.225	52.835	51.040
Sample vol. at std. cond., dscf ⁽¹⁾	53.107	53.006	53.177
Percent of isokinetic sampling	99.0	99.3	99.8

GAS STREAM COMPOSITION DATA:

CO ₂ , % by volume, dry basis	0.1	0.1	0.1
O ₂ , % by volume, dry basis	20.8	20.8	20.8
N ₂ , % by volume, dry basis	79.1	79.1	79.1
Molecular wt. of dry gas, lb/lb mole	28.85	28.85	28.85
H ₂ O vapor in gas stream, prop. by vol.	0.022	0.018	0.016
Mole fraction of dry gas	0.978	0.982	0.984
Molecular wt. of wet gas, lb/lb mole	28.61	28.66	28.67

GAS STREAM VELOCITY AND VOLUMETRIC FLOW DATA:

Static pressure, in. H ₂ O	-0.70	-0.70	-0.70
Absolute pressure, in. Hg	30.14	30.05	30.07
Avg. temperature, deg. F	65	73	70
Avg. absolute temperature, deg.R	525	533	530
Pitot tube coefficient	0.84	0.84	0.84
Total number of traverse points	12	12	12
Avg. gas stream velocity, ft./sec.	67.3	68.0	67.4
Stack/duct cross sectional area, sq.ft.	7.07	7.07	7.07
Avg. gas stream volumetric flow, wacf/min.	28544	28827	28576
Avg. gas stream volumetric flow, dscf/min.	28291	28170	28117

⁽¹⁾ Standard conditions = 68 deg. F. (20 deg. C.) and 29.92 in Hg (760 mm Hg)

TABLE 6-1 (cont.)
CHEMOURS - FAYETTEVILLE, NC
SUMMARY OF HFPO DIMER ACID TEST DATA AND TEST RESULTS
DIVISION STACK

TEST DATA			
Run number	1	2	3
Location	Divison Stack	Divison Stack	Divison Stack
Date	2/26/19	2/26/19	2/27/19
Time period	0927-1143	1335-1530	0840-1035
CONDITION			
	ABR Op.	Burnout Run	ABR Off
LABORATORY REPORT DATA, ug.			
HFPO Dimer Acid	1656.00	221.72	154.60
EMISSION RESULTS, ug/dscm.			
HFPO Dimer Acid	1100.95	147.68	102.65
EMISSION RESULTS, lb/dscf.			
HFPO Dimer Acid	6.87E-08	9.22E-09	6.41E-09
EMISSION RESULTS, lb/hr.			
HFPO Dimer Acid	1.17E-01	1.56E-02	1.08E-02
EMISSION RESULTS, g/sec.			
HFPO Dimer Acid	1.47E-02	1.96E-03	1.36E-03

TABLE 6-1 (cont.)
CHEMOURS - FAYETTEVILLE, NC
SUMMARY OF HFPO DIMER ACID TEST DATA AND TEST RESULTS
DIVISION STACK

Test Data

	4	5	6
Run number			
Location	Divison Stack	Divison Stack	Divison Stack
Date	2/27/19	2/28/19	2/28/19
Time period	1231-1426	0823-1018	1429-1627

SAMPLING DATA:

Sampling duration, min.	96.0	96.0	96.0
Nozzle diameter, in.	0.160	0.160	0.160
Cross sectional nozzle area, sq.ft.	0.000140	0.000140	0.000140
Barometric pressure, in. Hg	30.17	29.85	29.85
Avg. orifice press. diff., in H ₂ O	1.06	0.98	1.10
Avg. dry gas meter temp., deg F	73.8	59.0	69.7
Avg. abs. dry gas meter temp., deg. R	534	519	530
Total liquid collected by train, ml	30.5	16.9	26.5
Std. vol. of H ₂ O vapor coll., cu.ft.	1.4	0.8	1.2
Dry gas meter calibration factor	1.0069	1.0069	1.0069
Sample vol. at meter cond., dcf	52.690	50.670	53.878
Sample vol. at std. cond., dscf ⁽¹⁾	53.032	51.887	54.077
Percent of isokinetic sampling	98.6	96.3	99.2

GAS STREAM COMPOSITION DATA:

CO ₂ , % by volume, dry basis	0.1	0.1	0.1
O ₂ , % by volume, dry basis	20.8	20.8	20.8
N ₂ , % by volume, dry basis	79.1	79.1	79.1
Molecular wt. of dry gas, lb/lb mole	28.85	28.85	28.85
H ₂ O vapor in gas stream, prop. by vol.	0.026	0.015	0.023
Mole fraction of dry gas	0.974	0.985	0.977
Molecular wt. of wet gas, lb/lb mole	28.56	28.68	28.60

GAS STREAM VELOCITY AND VOLUMETRIC FLOW DATA:

Static pressure, in. H ₂ O	-0.70	-0.70	-0.70
Absolute pressure, in. Hg	30.12	29.80	29.80
Avg. temperature, deg. F	75	70	76
Avg. absolute temperature, deg.R	535	530	536
Pitot tube coefficient	0.84	0.84	0.84
Total number of traverse points	12	12	12
Avg. gas stream velocity, ft./sec.	69.2	68.6	70.8
Stack/duct cross sectional area, sq.ft.	7.07	7.07	7.07
Avg. gas stream volumetric flow, wacf/min.	29366	29099	30020
Avg. gas stream volumetric flow, dscf/min.	28382	28433	28771

⁽¹⁾ Standard conditions = 68 deg. F. (20 deg. C.) and 29.92 in Hg (760 mm Hg)

TABLE 6-1 (cont.)
CHEMOURS - FAYETTEVILLE, NC
SUMMARY OF HFPO DIMER ACID TEST DATA AND TEST RESULTS
DIVISION STACK

TEST DATA	4	5	6
Run number			
Location	Divison Stack	Divison Stack	Divison Stack
Date	2/27/19	2/28/19	2/28/19
Time period	1231-1426	0823-1018	1429-1627
CONDITION	ABR Op.	ABR Op.	Burnout Run
LABORATORY REPORT DATA, ug.			
HFPO Dimer Acid	1699.08	2087.79	598.04
EMISSION RESULTS, ug/dscm.			
HFPO Dimer Acid	1131.18	1420.66	390.46
EMISSION RESULTS, lb/dscf.			
HFPO Dimer Acid	7.06E-08	8.87E-08	2.44E-08
EMISSION RESULTS, lb/hr.			
HFPO Dimer Acid	1.20E-01	1.51E-01	4.21E-02
EMISSION RESULTS, g/sec.			
HFPO Dimer Acid	1.51E-02	1.91E-02	5.30E-03

TABLE 6-1 (cont.)
CHEMOURS - FAYETTEVILLE, NC
SUMMARY OF HFPO DIMER ACID TEST DATA AND TEST RESULTS
DIVISION STACK

Test Data

	7	8
Run number		
Location	Divison Stack	Divison Stack
Date	3/01/19	3/01/19
Time period	0813-1008	1237-1433

SAMPLING DATA:

Sampling duration, min.	96.0	96.0
Nozzle diameter, in.	0.160	0.160
Cross sectional nozzle area, sq.ft.	0.000140	0.000140
Barometric pressure, in. Hg	29.99	29.99
Avg. orifice press. diff., in H ₂ O	1.08	1.10
Avg. dry gas meter temp., deg F	53.9	64.9
Avg. abs. dry gas meter temp., deg. R	514	525
Total liquid collected by train, ml	16.9	24.9
Std. vol. of H ₂ O vapor coll., cu.ft.	0.8	1.2
Dry gas meter calibration factor	1.0069	1.0069
Sample vol. at meter cond., dcf	52.282	53.575
Sample vol. at std. cond., dscf ⁽¹⁾	54.339	54.518
Percent of isokinetic sampling	98.3	98.9

GAS STREAM COMPOSITION DATA:

CO ₂ , % by volume, dry basis	0.1	0.1
O ₂ , % by volume, dry basis	20.8	20.8
N ₂ , % by volume, dry basis	79.1	79.1
Molecular wt. of dry gas, lb/lb mole	28.85	28.85
H ₂ O vapor in gas stream, prop. by vol.	0.014	0.021
Mole fraction of dry gas	0.986	0.979
Molecular wt. of wet gas, lb/lb mole	28.69	28.62

GAS STREAM VELOCITY AND VOLUMETRIC FLOW DATA:

Static pressure, in. H ₂ O	-0.70	-0.70
Absolute pressure, in. Hg	29.94	29.94
Avg. temperature, deg. F	66	71
Avg. absolute temperature, deg.R	526	531
Pitot tube coefficient	0.84	0.84
Total number of traverse points	12	12
Avg. gas stream velocity, ft./sec.	69.4	70.5
Stack/duct cross sectional area, sq.ft.	7.07	7.07
Avg. gas stream volumetric flow, wacf/min.	29452	29901
Avg. gas stream volumetric flow, dscf/min.	29166	29094

⁽¹⁾ Standard conditions = 68 deg. F. (20 deg. C.) and 29.92 in Hg (760 mm Hg)

TABLE 6-1 (cont.)
CHEMOURS - FAYETTEVILLE, NC
SUMMARY OF HFPO DIMER ACID TEST DATA AND TEST RESULTS
DIVISION STACK

TEST DATA			
Run number		7	8
Location		Divison Stack	Divison Stack
Date		3/01/19	3/01/19
Time period		0813-1008	1237-1433
CONDITION		ABR Op.	Burnout Run
LABORATORY REPORT DATA, ug.			
HFPO Dimer Acid		1480.24	248.02
EMISSION RESULTS, ug/dscm.			
HFPO Dimer Acid		961.80	160.62
EMISSION RESULTS, lb/dscf.			
HFPO Dimer Acid		6.01E-08	1.00E-08
EMISSION RESULTS, lb/hr.			
HFPO Dimer Acid		1.05E-01	1.75E-02
EMISSION RESULTS, g/sec.			
HFPO Dimer Acid		1.32E-02	2.20E-03

TABLE 6-2
CHEMOURS - FAYETTEVILLE, NC
SUMMARY OF HFPO DIMER ACID TEST DATA AND TEST RESULTS
BLOWER INTAKE

Test Data

	1	2	3
Run number			
Location	Blower Intake	Blower Intake	Blower Intake
Date	2/26/19	2/26/19	2/27/19
Time period	0927-1143	1335-1530	0840-1035

SAMPLING DATA:

Sampling duration, min.	135.0	115.0	115.0
Nozzle diameter, in.	0.365	0.365	0.365
Cross sectional nozzle area, sq.ft.	0.000727	0.000727	0.000727
Barometric pressure, in. Hg	29.29	30.20	30.22
Avg. orifice press. diff., in H ₂ O	3.00	3.00	3.00
Avg. dry gas meter temp., deg F	60.4	78.3	65.1
Avg. abs. dry gas meter temp., deg. R	520	538	525
Total liquid collected by train, ml	27.6	27.5	29.4
Std. vol. of H ₂ O vapor coll., cu.ft.	1.3	1.3	1.4
Dry gas meter calibration factor	1.0100	1.0100	1.0100
Sample vol. at meter cond., dcf	128.621	109.397	107.605
Sample vol. at std. cond., dscf ⁽¹⁾	129.951	110.154	111.132

GAS STREAM COMPOSITION DATA:

CO ₂ , % by volume, dry basis	0.0	0.0	0.0
O ₂ , % by volume, dry basis	20.9	20.9	20.9
N ₂ , % by volume, dry basis	79.1	79.1	79.1
Molecular wt. of dry gas, lb/lb mole	28.84	28.84	28.84
H ₂ O vapor in gas stream, prop. by vol.	0.010	0.012	0.012
Mole fraction of dry gas	0.990	0.988	0.988
Molecular wt. of wet gas, lb/lb mole	28.73	28.71	28.70

⁽¹⁾ Standard conditions = 68 deg. F. (20 deg. C.) and 29.92 in Hg (760 mm Hg)

TABLE 6-2 (cont.)
CHEMOURS - FAYETTEVILLE, NC
SUMMARY OF HFPO DIMER ACID TEST DATA AND TEST RESULTS
BLOWER INTAKE

TEST DATA			
	1	2	3
Run number			
Location	Blower Intake	Blower Intak	Blower Intake
Date	2/26/19	2/26/19	2/27/19
Time period	0927-1143	1335-1530	0840-1035
CONDITION			
	ABR Op.	Burnout Run	ABR Off
LABORATORY REPORT DATA, ug.			
HFPO Dimer Acid	0.92	0.38	0.66
EMISSION RESULTS, ug/dscm.			
HFPO Dimer Acid	0.25	0.12	0.21
EMISSION RESULTS, lb/dscf.			
HFPO Dimer Acid	1.55E-11	7.66E-12	1.31E-11

TABLE 6-2 (cont.)
CHEMOURS - FAYETTEVILLE, NC
SUMMARY OF HFPO DIMER ACID TEST DATA AND TEST RESULTS
BLOWER INTAKE

Test Data

	4	5	6
Run number			
Location	Blower Intake	Blower Intake	Blower Intake
Date	2/27/19	2/28/19	2/28/19
Time period	1231-1426	0823-1018	1429-1627

SAMPLING DATA:

Sampling duration, min.	115.0	0.6	118.0
Nozzle diameter, in.	0.365	0.365	0.365
Cross sectional nozzle area, sq.ft.	0.000727	0.000727	0.000727
Barometric pressure, in. Hg	30.17	29.95	29.95
Avg. orifice press. diff., in H ₂ O	3.00	3.00	3.00
Avg. dry gas meter temp., deg F	73.6	63.4	81.8
Avg. abs. dry gas meter temp., deg. R	534	523	542
Total liquid collected by train, ml	45.9	40.7	36.4
Std. vol. of H ₂ O vapor coll., cu.ft.	2.2	1.9	1.7
Dry gas meter calibration factor	1.0100	1.0100	1.0100
Sample vol. at meter cond., dcf	106.883	106.308	110.497
Sample vol. at std. cond., dscf ⁽¹⁾	108.454	109.171	109.630

GAS STREAM COMPOSITION DATA:

CO ₂ , % by volume, dry basis	0.0	0.0	0.0
O ₂ , % by volume, dry basis	20.9	20.9	20.9
N ₂ , % by volume, dry basis	79.1	79.1	79.1
Molecular wt. of dry gas, lb/lb mole	28.84	28.84	28.84
H ₂ O vapor in gas stream, prop. by vol.	0.020	0.017	0.015
Mole fraction of dry gas	0.980	0.983	0.985
Molecular wt. of wet gas, lb/lb mole	28.62	28.65	28.67

⁽¹⁾ Standard conditions = 68 deg. F. (20 deg. C.) and 29.92 in Hg (760 mm Hg)

TABLE 6-2 (cont.)
CHEMOURS - FAYETTEVILLE, NC
SUMMARY OF HFPO DIMER ACID TEST DATA AND TEST RESULTS
BLOWER INTAKE

TEST DATA			
Run number	4	5	6
Location	Blower Intake	Blower Intake	Blower Intake
Date	2/27/19	2/28/19	2/28/19
Time period	1231-1426	0823-1018	1429-1627
CONDITION	ABR Op.	ABR Op.	Burnout Run
LABORATORY REPORT DATA, ug.			
HFPO Dimer Acid	0.53	0.60	2.88
EMISSION RESULTS, ug/dscm.			
HFPO Dimer Acid	0.17	0.19	0.93
EMISSION RESULTS, lb/dscf.			
HFPO Dimer Acid	1.07E-11	1.22E-11	5.79E-11

TABLE 6-2 (cont.)
CHEMOURS - FAYETTEVILLE, NC
SUMMARY OF HFPO DIMER ACID TEST DATA AND TEST RESULTS
BLOWER INTAKE

Test Data

	7	8
Run number		
Location	Blower Intake	Blower Intake
Date	3/1/19	3/1/19
Time period	0813-1008	1237-1433

SAMPLING DATA:

Sampling duration, min.	115.0	115.0
Nozzle diameter, in.	0.365	0.365
Cross sectional nozzle area, sq.ft.	0.000727	0.000727
Barometric pressure, in. Hg	30.09	30.09
Avg. orifice press. diff., in H ₂ O	3.00	3.00
Avg. dry gas meter temp., deg F	61.0	70.2
Avg. abs. dry gas meter temp., deg. R	521	530
Total liquid collected by train, ml	32.5	36.0
Std. vol. of H ₂ O vapor coll., cu.ft.	1.5	1.7
Dry gas meter calibration factor	1.0100	1.0100
Sample vol. at meter cond., dcf	105.079	106.831
Sample vol. at std. cond., dscf ⁽¹⁾	108.916	108.807

GAS STREAM COMPOSITION DATA:

CO ₂ , % by volume, dry basis	0.0	0.0
O ₂ , % by volume, dry basis	20.9	20.9
N ₂ , % by volume, dry basis	79.1	79.1
Molecular wt. of dry gas, lb/lb mole	28.84	28.84
H ₂ O vapor in gas stream, prop. by vol.	0.014	0.015
Mole fraction of dry gas	0.986	0.985
Molecular wt. of wet gas, lb/lb mole	28.69	28.67

⁽¹⁾ Standard conditions = 68 deg. F. (20 deg. C.) and 29.92 in Hg (760 mm Hg)

TABLE 6-2 (cont.)
CHEMOURS - FAYETTEVILLE, NC
SUMMARY OF HFPO DIMER ACID TEST DATA AND TEST RESULTS
BLOWER INTAKE

TEST DATA			
Run number		7	8
Location		Blower Intake	Blower Intake
Date		3/1/19	3/1/19
Time period		0813-1008	1237-1433
CONDITION			
		ABR Op.	Burnout Run
LABORATORY REPORT DATA, ug.			
HFPO Dimer Acid		0.69	0.30
EMISSION RESULTS, ug/dscm.			
HFPO Dimer Acid		0.23	0.10
EMISSION RESULTS, lb/dscf.			
HFPO Dimer Acid		1.41E-11	6.17E-12

APPENDIX A
PROCESS OPERATIONS DATA

Date 2/26/2019

Time	800	900	1000	1100	1200	1300	1400	1500	1600	
Stack Testing			Run 1				Run 2			
HFPO										
VEN Product	PPVE									
VEN Precursor										
VEN Condensation (HFPO)										
VEN ABR							Burnout			
VEN Refining										
Stripper Column Vent										
Division WGS Recirculation Flow	15000 kg/h									
Division WGS Inlet Flow	125 kg/h					105 kg/h		90 kg/h		70 kg/h

Date 2/27/2019

Time	800	900	1000	1100	1200	1300	1400	1500	1600	
Stack Testing		Run 3				Run 4				
HFPO										
VEN Product	PPVE									
VEN Precursor										
VEN Condensation (HFPO)										
VEN ABR										
VEN Refining										
Stripper Column Vent										
Division WGS Recirculation Flow	15000 kg/h									
Division WGS Inlet Flow	75 kg/h			98 kg/h		140 kg/h		125 kg/h		145 kg/h

Date **2/28/2019**

Time	800	900	1000	1100	1200	1300	1400	1500	1600
Stack Testing	Run 5				Run 6				
HFPO									
VEN Product	PPVE								
VEN Precursor									
VEN Condensation (HFPO)									
VEN ABR								Burnout	
VEN Refining									
Stripper Column Vent									
Division WGS Recirculation Flow	15000 kg/h								
Division WGS Inlet Flow	125 kg/h							100 kg/h	

Date **3/1/2019**

Time	800	900	1000	1100	1200	1300	1400	1500	1600
Stack Testing	Run 7			Run 8					
HFPO									
VEN Product	PPVE								
VEN Precursor									
VEN Condensation (HFPO)									
VEN ABR						Burnout			
VEN Refining									
Stripper Column Vent									
Division WGS Recirculation Flow	15000 kg/h								
Division WGS Inlet Flow	120 kg/h					80 kg/h			60 kg/h

APPENDIX B
RAW AND REDUCED TEST DATA

CHEMOURS - FAYETTEVILLE, NC
INPUTS FOR HFPO DIMER ACID CALCULATIONS
DIVISION STACK

Test Data

	1	2	3
Run number			
Location	Divison Stack	Divison Stack	Divison Stack
Date	2/26/19	2/26/19	2/27/19
Time period	0927-1143	1335-1530	0840-1035
Operator	MW	MW	MW

Inputs For Calcs.

Sq. rt. delta P	1.20126	1.20298	1.19608
Delta H	1.0488	1.0367	1.0107
Stack temp. (deg.F)	64.7	72.8	70.3
Meter temp. (deg.F)	68.7	74.3	54.8
Sample volume (act.)	52.225	52.835	51.040
Barometric press. (in.Hg)	30.19	30.10	30.12
Volume H ₂ O imp. (ml)	10.0	3.0	6.0
Weight change sil. gel (g)	15.2	17.2	12.7
% CO ₂	0.1	0.1	0.1
% O ₂	20.8	20.8	20.8
% N ₂	79.1	79.1	79.1
Area of stack (sq.ft.)	7.070	7.070	7.070
Sample time (min.)	96.0	96.0	96.0
Static pressure (in.H ₂ O)	-0.70	-0.70	-0.70
Nozzle dia. (in.)	0.160	0.160	0.160
Meter box cal.	1.0069	1.0069	1.0069
Cp of pitot tube	0.84	0.84	0.84
Traverse points	12	12	12

ISOKINETIC FIELD DATA SHEET

EPA Method 0010 - HFPO Dimer Acid

Client Chemours
 W.O.# 15418
 Project ID Chemours % Moisture
 Mode/Source ID Division Impinger Vol (ml)
 Samp. Loc. ID STK Silica gel (g)
 Run No. ID 1 CO2, % by Vol
 Test Method ID M0010 O2, % by Vol
 Date ID 25FEB2019 Temperature (°F)
 Source/Location Division Stack Meter Temp (°F)
 Sample Date 2/26/19 ✓ Static Press (in H2O)
 Baro. Press (in Hg) 30.19 ✓ Ambient Temp (°F)
 Operator MR WINKLER ✓

Stack Conditions

Assumed	Actual
2.0	10.0
	15.2
0.1	✓
20.8	✓
60	
-4.8	
-0.70	✓
~40	

Meter Box ID 12
 Meter Box Y 1.0069
 Meter Box Del H 1.3812
 Probe ID / Length 700 5
 Probe Material Boro
 Pitot / Thermocouple ID P700
 Pitot Coefficient 0.84 ✓
 Nozzle ID 0.160 0.160 0.160
 Nozzle Measurements 0.160 0.160 0.160
 Avg Nozzle Dia (in) 0.160 ✓
 Area of Stack (ft²) 7.07 ✓
 Sample Time 96
 Total Traverse Pts 12 ✓

K Factor 0.727

Initial	Mid-Point	Final
0.001	0.001	0.001
2.15	2.5	2.6
yes / no	yes / no	yes / no
yes / no	yes / no	yes / no
yes / no	yes / no	yes / no
Pre-Test Set	Post-Test Set	
52	68	
51	68	
Pass / Fail	Pass / Fail	
yes / no	yes / no	

TRAVERSE POINT	NO.	SAMPLE TIME (min)	CLOCK TIME (plant time)	VELOCITY PRESSURE Delta P (in H2O)	ORIFICE PRESSURE Delta H (in H2O)	DRY GAS METER READING (ft³)	STACK TEMP (°F)	DCM OUTLET TEMP (°F)	PROBE TEMP (°F)	FILTER BOX TEMP (°F)	IMPINGER EXIT TEMP (°F)	SAMPLE TRAIN VAC (in Hg)	XAD EXIT TEMP (°F)	COMMENTS
		0	0927 ✓			795.140								
A	1	4		1.4	1.01	797.26	60	57	100	100	47	3	47	
	1	8		1.4	1.01	799.68	60	57	100	100	47	3	47	
	2	12		1.2	0.87	801.78	61	59	100	100	45	3	45	26.195
	2	16		1.2	0.87	803.16	61	59	100	100	45	3	45	
	3	20		1.9	1.38	806.01	62	61	101	102	45	3	45	
	3	24		1.9	1.38	808.50	62	61	100	100	45	4	45	
	4	28		1.3	1.30	810.96	63	61	100	100	45	4	45	
	4	32		1.3	1.30	813.15	63	63	103	102	46	4	46	
	5	36		1.4	1.01	815.43	64	65	103	102	47	3	47	
	5	40		1.4	1.01	817.60	64	66	102	101	48	3	48	
	6	44		1.0	0.72	819.42	66	67	101	100	50	3	50	
	6	48	1015 1055	1.0	0.72	821.335	66	67	101	100	50	2	50	
						821.400								
B	1	4		1.1	0.726	823.330	65	70	101	101	59	2	59	K-FACTOR
	1	8		1.1	0.726	825.21	65	73	101	101	59	2	59	← 0.715
	2	12		1.6	1.14	827.40	66	75	100	100	55	3	55	
	2	16		1.6	1.14	829.60	66	75	100	100	55	3	55	26.030
	3	20		1.8	1.28	832.02	66	76	100	100	55	3	55	
	3	24		1.8	1.28	834.40	66	76	100	100	53	3	53	
	4	28		1.9	1.35	836.86	67	76	100	100	53	4	53	
	4	32		1.9	1.35	839.55	67	76	100	100	53	4	53	
	5	36		1.5	1.07	841.56	68	76	100	100	54	4	54	
	5	40		1.5	1.07	843.80	68	76	100	100	54	4	54	
	6	44		0.95	0.67	845.65	68	78	100	100	55	2	55	
	6	48	1143 ✓	0.95	0.67	847.430	68	78	100	100	55	2	55	

Avg Delta P ✓	Avg Delta H ✓	Total Volume ✓	Avg Ts ✓	Avg Tm ✓	Min/Max	Min/Max ✓	Max	Max Vac	Min/Max
1.40250	1.04333	52.225	64.6	68.6	100/103	100/102	59	4	46/59
Avg Sqrt Delta P ✓	Avg Sqrt Del H ✓	Comments:							
1.20126	1.01722								

ISOKINETIC FIELD DATA SHEET

EPA Method 0010 - HFPO Dimer Acid

Client Chemours
 W.O.# 15418
 Project ID Chemours % Moisture
 Mode/Source ID Division Impinger Vol (ml)
 Samp. Loc. ID STK Silica gel (g)
 Run No. ID 2 CO2, % by Vol
 Test Method ID M0010 O2, % by Vol
 Date ID 25FEB2019 Temperature (°F)
 Source/Location Division Stack Meter Temp (°F)
 Sample Date 2/26/19 Static Press (In H2O)
 Baro. Press (In Hg) 30.10 Ambient Temp (°F)
 Operator W. WINKLER

Stack Conditions
 Assumed Actual
 = 2.0
 3
 0.1
 17.2
 10.8
 -72
 -0.70
 = 63
 (BURNOUT PHASE)

Meter Box ID 12
 Meter Box Y 1.0069 ✓
 Meter Box Del H 1.8812
 Probe ID / Length 700 5
 Probe Material Boro
 Pitot / Thermocouple ID P700
 Pitot Coefficient 0.84 ✓
 Nozzle ID 0160
 Nozzle Measurements 0.160 0.160 0.160
 Avg Nozzle Dia (in) 0.160 ✓
 Area of Stack (ft²) 7.07 ✓
 Sample Time 96 ✓
 Total Traverse Pts 12 ✓

Sample Train (ft³) 0.001 0.015 0.015
 Leak Check @ (In Hg) 2.5 6 7
 Pitot leak check good Yes / no Yes / no Yes / no
 Pitot inspection good Yes / no Yes / no Yes / no
 Method 3 System good yes / no yes / no yes / no
Temp Check
 Meter Box Temp 63 60
 Reference Temp 63 60
 Pass/Fail (+/- 2°) Pass / Fail Pass / Fail
 Temp Change Response? Yes / no Yes / no

K Factor 0.713

TRAVERSE POINT NO.	SAMPLE TIME (min)	CLOCK TIME (plant time)	VELOCITY PRESSURE Delta P (in H2O)	ORIFICE PRESSURE Delta H (in H2O)	DRY GAS METER READING (ft³)	STACK TEMP (°F)	DGM OUTLET TEMP (°F)	PROBE TEMP (°F)	FILTER BOX TEMP (F)	IMPINGER EXIT TEMP (°F)	SAMPLE TRAIN VAC (in Hg)	XAD EXIT TEMP (F)	COMMENTS
	0	1335 ✓			847.515								
A 1	4		1.2	0.855	849.62	72	73	102	101	64	3	64	
1	8		1.2	0.855	851.65	72	74	103	103	58	3	58	
2	12		1.6	1.14	853.86	72	74	102	102	56	3	56	
2	16		1.6	1.14	856.56	72	75	102	102	56	3	56	26.585
3	20		1.7	1.21	858.72	72	75	100	100	55	3	55	
3	24		1.7	1.21	860.95	72	75	100	100	55	3	55	
4	28		1.8	1.28	863.35	72	74	100	100	55	3	55	
4	32		1.8	1.28	865.61	72	74	100	100	62	3	62	
5	36		1.4	0.99	867.77	72	74	102	102	62	3	62	
5	40		1.4	0.99	869.90	72	74	100	100	62	3	62	
6	44		1.2	0.85	871.93	72	73	100	100	64	2	64	
6	48	1423	1.2	0.85	873.95	72	73	100	100	64	2	64	
		1442			874.100								
B 1	4		1.2	0.855	876.20	73	69	100	100	65	2	65	
1	8		1.2	0.855	879.40	73	69	100	100	65	2	65	26.400
2	12		1.6	1.14	880.50	73	72	100	100	65	3	65	
2	16		1.6	1.14	882.84	73	73	100	100	60	3	60	
3	20		1.7	1.21	886.20	74	75	101	101	59	4	59	
3	24		1.7	1.21	887.72	74	75	101	101	59	4	59	
4	28		1.7	1.21	890.01	74	76	103	100	60	4	60	
4	32		1.7	1.21	892.88	74	77	103	100	60	4	60	
5	36		1.4	0.99	894.67	74	77	103	100	55	3	55	
5	40		1.4	0.99	896.77	74	77	101	101	55	3	55	
6	44		1.0	0.71	898.61	74	77	100	102	56	3	56	
6	48	1530 ✓	1.0	0.71	900.500	74	77	100	100	56	3	56	

Avg Delta P 1.45833
 Avg Delta H 1.03667
 Total Volume 529.855
 Avg Tsv 72.8
 Avg Tm 74.3
 Min/Max 100/103
 Min/Max 100/103
 Max 65
 Max Vac 4
 Min/Max 55/65
 Comments:



ISOKINETIC FIELD DATA SHEET

EPA Method 0010 - HFPO Dimer Acid

Client: Chemours
 W.O.#: 15418
 Project ID: Chemours
 Mode/Source ID: Division
 Samp. Loc. ID: STK
 Run No. ID: 3
 Test Method ID: M0010
 Date ID: 25FEB2019
 Source/Location: Division Stack
 Sample Date: 2/27/19
 Baro. Press (in Hg): 30.12
 Operator: M. WINKLER

Stack Conditions	
Assumed	Actual
#2	
	7
	22.4
0.1	✓
20.8	✓
60	
250	
-0.70	✓
255	

Meter Box ID: 12
 Meter Box Y: 1.0069 ✓
 Meter Box Del H: 2812
 Probe ID / Length: 700 / 5
 Probe Material: Boro
 Pitot / Thermocouple ID: P700
 Pitot Coefficient: 0.84
 Nozzle ID: G1160
 Nozzle Measurements: 0.160 | 0.160 | 0.160
 Avg Nozzle Dia (in): 0.160 ✓
 Area of Stack (ft²): 7.07 ✓
 Sample Time: 96 ✓
 Total Traverse Pts: 13 ✓

Sample Train (ft³):
 Leak Check @ (in Hg):
 Pitot leak check good:
 Pitot inspection good:
 Method 3 System good:
 Temp Check:
 Meter Box Temp:
 Reference Temp:
 Pass/Fail (+/- 2°):
 Temp Change Response:

K Factor 0.707		
Initial	Mid-Point	Final
0.001	0.001	0.015
0.15	0.6	0.5
yes / no	yes / no	yes / no
yes / no	yes / no	yes / no
yes / no	yes / no	yes / no
Pre-Test Set		Post-Test Set
54		60
54		60
Pass / Fail		Pass / Fail
yes / no		yes / no

TRAVERSE POINT NO.	SAMPLE TIME (min)	CLOCK TIME (plant time)	VELOCITY PRESSURE Delta P (in H2O)	ORIFICE PRESSURE Delta H (in H2O)	DRY GAS METER READING (ft³)	STACK TEMP (°F)	DGM OUTLET TEMP (°F)	PROBE TEMP (°F)	FILTER BOX TEMP (°F)	IMPINGER EXIT TEMP (°F)	SAMPLE TRAIN VAC (in Hg)	XAD EXIT TEMP (°F)	COMMENTS
	0	0840V			900.610								
1	4		1.2	0.848	902.52	67	51	100	103	49	2	49	
1	8		1.2	0.848	904.52	67	51	100	101	49	2	49	
2	12		1.6	1.13	906.73	67	52	100	101	44	3	44	25.500
2	16		1.6	1.13	909.01	67	52	100	101	44	3	44	
3	20		1.7	1.20	911.39	67	53	103	101	38	4	38	
3	24		1.7	1.20	913.26	67	53	102	102	38	4	38	
4	28		1.7	1.20	915.76	68	54	102	102	39	4	39	
4	32		1.7	1.20	918.62	68	54	102	102	40	4	40	
5	36		1.3	0.92	920.26	68	55	102	102	41	3	41	
5	40		1.3	0.92	922.31	68	55	101	101	41	3	41	
6	44		1.1	0.77	924.30	68	56	100	100	42	3	42	
6	48	0928	1.1	0.77	926.010	68	56	100	100	42	3	42	
		0947			926.110								
1	4		1.3	0.92	928.18	72	50	101	100	58	3	56	
1	8		1.3	0.92	930.26	72	50	101	100	53	3	52	
2	12		1.7	1.20	932.60	73	54	103	100	53	3	52	
2	16		1.7	1.20	934.90	73	54	103	101	53	3	53	K FACTOR
3	20		1.7	1.20	937.62	73	54	103	101	53	3	53	0.688
3	24		1.7	1.20	939.53	74	54	102	101	53	3	53	
4	28		1.6	1.10	941.80	74	55	100	100	48	3	48	25.09
4	32		1.6	1.10	944.00	74	55	100	100	48	2	48	
5	36		1.4	0.96	946.13	73	60	101	100	49	2	49	
5	40		1.4	0.96	948.10	73	61	103	103	49	2	49	
6	44		1.0	0.68	949.93	73	61	100	100	53	2	53	
6	48	1035J	1.0	0.68	951.750	73	61	100	100	53	2	53	

Avg Delta P	1.4167 ✓	Avg Delta H	1.01061	Total Volume	51.14 ✓	Avg Ts	70.3	Avg Tm	54.8 ✓	Min/Max	100/103	Min/Max	100/103	Max	52	Max Vac	4	Min/Max	38/50
Avg Sqrt Delta P	1.19608	Avg Sqrt Del H	1.00122	Comments:															



SAMPLE RECOVERY FIELD DATA

EPA Method 0010 - HFPO Dimer Acid

Client Chemours W.O. # 15418
 Location/Plant Fayetteville, NC Source & Location Division Stack

Run No. 1 Sample Date 2/26/19 Recovery Date 2/26/19
 Sample I.D. Chemours - Gas - STK - 1 - M0010 - Analyst PMV Filter Number NA

	Impinger							Imp.Total	8	Total
	1	2	3	4	5	6	7			
Contents	Empty	HPLC H2O	HPLC H2O						Silica Gel	
Final	2	102	103	3	/	/	/		315.2	
Initial	0	100	100	0	/	/	/		300	
Gain	2	2	3	3	/	/	/	10	15.2	

Impinger Color clear Labeled? ✓
 Silica Gel Condition Good Sealed? ✓

Run No. 2 Sample Date 2/26/19 Recovery Date 2/26/19
 Sample I.D. Chemours - Gas - STK - 2 - M0010 - Analyst PMV Filter Number NA

	Impinger							Imp.Total	8	Total
	1	2	3	4	5	6	7			
Contents	Empty	HPLC H2O	HPLC H2O						Silica Gel	
Final	2	97	101	3					317.2	
Initial	0	100	100	0					300	
Gain	2	-3	1	3				3	17.2	

Impinger Color clear Labeled? ✓
 Silica Gel Condition Good Sealed? ✓

Run No. 3 Sample Date 2/27/19 Recovery Date 2/27/19
 Sample I.D. Chemours - Gas - STK - 3 - M0010 - Analyst PMV Filter Number NA

	Impinger							Imp.Total	8	Total
	1	2	3	4	5	6	7			
Contents	Empty	HPLC H2O	HPLC H2O						Silica Gel	
Final	4	105	98	1					312.7	
Initial	0	100	100	0					300	
Gain	4	5	-2	1				7	12.7	

Impinger Color clear Labeled? ✓
 Silica Gel Condition Good Sealed? ✓

Check COC for Sample IDs of Media Blanks



CHEMOURS - FAYETTEVILLE, NC
INPUTS FOR HFPO DIMER ACID CALCULATIONS
DIVISION STACK

Test Data

Run number	4	5	6
Location	Divison Stack	Divison Stack	Divison Stack
Date	2/27/19	2/28/19	2/28/19
Time period	1231-1426	0823-1018	1429-1627
Operator	MW	MW	MW

Inputs For Calcs.

Sq. rt. delta P	1.22215	1.21328	1.24262
Delta H	1.0642	0.9783	1.0988
Stack temp. (deg.F)	75.2	69.8	76.1
Meter temp. (deg.F)	73.8	59.0	69.7
Sample volume (act.)	52.690	50.670	53.878
Barometric press. (in.Hg)	30.17	29.85	29.85
Volume H ₂ O imp. (ml)	14.0	3.0	7.0
Weight change sil. gel (g)	16.5	13.9	19.5
% CO ₂	0.1	0.1	0.1
% O ₂	20.8	20.8	20.8
% N ₂	79.1	79.1	79.1
Area of stack (sq.ft.)	7.070	7.070	7.070
Sample time (min.)	96.0	96.0	96.0
Static pressure (in.H ₂ O)	-0.70	-0.70	-0.70
Nozzle dia. (in.)	0.160	0.160	0.160
Meter box cal.	1.0069	1.0069	1.0069
Cp of pitot tube	0.84	0.84	0.84
Traverse points	12	12	12

ISOKINETIC FIELD DATA SHEET

EPA Method 0010 - HFPO Dimer Acid

Client Chemours
 W.O.# 15418
 Project ID Chemours % Moisture
 Mode/Source ID Division Impinger Vol (ml)
 Samp. Loc. ID STK Silica gel (g)
 Run No. ID 4 CO2, % by Vol
 Test Method ID M0010 O2, % by Vol
 Date ID 25FEB2019 Temperature (°F)
 Source/Location Division Stack Meter Temp (°F)
 Sample Date 2/27/19 Static Press (In H2O)
 Baro. Press (In Hg) 30.17 Ambient Temp (°F)
 Operator M. W. J. K. W. J. K. W. J. K.

Stack Conditions	
Assumed	Actual
22	11
	16.5
0.1	✓
20.2	✓
60	
750	
-0.70	✓
60	

Meter Box ID 12
 Meter Box Y 1.0069 ✓
 Meter Box Del H 1.2812
 Probe ID / Length 695 / 5
 Probe Material Boro
 Pitot / Thermocouple ID P700 P695
 Pitot Coefficient 0.84 ✓
 Nozzle ID G-160
 Nozzle Measurements 0.160 0.160 0.160
 Avg Nozzle Dia (in) 0.160 ✓
 Area of Stack (ft²) 7.07 ✓
 Sample Time 96 ✓
 Total Traverse Pts 12 ✓

K Factor 0.713		
Initial	Mid-Point	Final
0.001	0.001	0.001
0.15	0.5	0.5
yes / no	yes / no	yes / no
yes / no	yes / no	yes / no
yes / no	yes / no	yes / no
Pre-Test Set		Post-Test Set
60		
60		
Pass / Fail		Pass / Fail
yes / no		yes / no

TRAVERSE POINT	SAMPLE NO.	CLOCK TIME (plant time)	VELOCITY PRESSURE Delta P (in H2O)	ORIFICE PRESSURE Delta H (in H2O)	DRY GAS METER READING (ft³)	STACK TEMP (°F)	DGM OUTLET TEMP (°F)	PROBE TEMP (°F)	FILTER BOX TEMP (F)	IMPINGER EXIT TEMP (oF)	SAMPLE TRAIN VAC (in Hg)	XAD EXIT TEMP (F)	COMMENTS
	0	1231 ✓			952.250								
A	1	9	1.3	0.92	954.90	74	69	100	94	44	2	44	
	2	12	1.3	0.92	956.82	74	69	101	100	44	2	44	
	2	16	1.6	1.14	958.95	74	70	103	105	43	3	43	26.046
	3	20	1.6	1.14	960.12	74	70	101	103	43	3	43	
	3	24	1.8	1.28	963.67	75	71	100	102	44	3	44	
	4	28	1.8	1.28	966.25	75	72	100	102	49	3	49	
	4	32	1.7	1.21	968.48	75	72	101	101	49	3	49	
	5	36	1.7	1.21	970.72	75	72	101	101	49	3	49	
	5	40	1.4	0.99	973.68	75	73	100	100	44	3	44	
	6	44	1.1	0.78	975.20	75	73	100	100	44	3	44	
	6	48	1.1	0.78	977.33	75	73	100	101	44	2	44	
		1319			978.899	75	73	100	101	44	2	44	
		1338			979.056	75	73	100	101	44	2	44	
	1	4	1.4	0.99	981.22	75	76	100	100	48	3	48	
	1	8	1.4	0.99	983.41	75	76	100	101	48	3	48	
	2	12	1.6	1.13	985.39	76	75	103	105	47	4	47	k-factor
	2	16	1.6	1.13	987.90	76	75	103	105	47	4	47	← 0.707
	3	20	1.9	1.34	990.42	76	75	101	101	47	4	47	26.644
	3	24	1.9	1.34	992.75	76	75	100	100	46	4	46	
	4	28	1.7	1.20	994.65	76	77	104	104	52	3	52	
	4	32	1.7	1.20	997.65	76	77	104	104	52	3	52	
	5	36	1.4	0.98	999.70	75	77	100	100	54	3	54	
	5	40	1.3	1.06	1001.90	76	77	100	100	54	3	54	
	6	44	1.1	0.77	1003.80	76	77	101	101	56	2	56	
	6	48	1.1	0.77	1005.700	76	77	101	101	56	2	56	

Avg Delta P	1.50417	Avg Delta H	1.06417	Total Volume	52.69	Avg Ts	75.7	Avg Tm	73.7	Min/Max	100/103	Min/Max	94/105	Max	56	Max Vac	4	Min/Max	43/56
Avg Sqrt Delta P	1.22215	Avg Sqrt Del H	1.02789	Comments:															

V
 AMMA



ISOKINETIC FIELD DATA SHEET

EPA Method 0010 - HFPO Dimer Acid

Client: Chemours
 W.O.#: 15418
 Project ID: Chemours % Moisture
 Mode/Source ID: Division Impinger Vol (ml)
 Samp. Loc. ID: STK Silica gel (g)
 Run No. ID: 5 CO2, % by Vol
 Test Method ID: M0010 O2, % by Vol
 Date ID: 25FEB2019 Temperature (°F)
 Source/Location: Division Stack Meter Temp (°F)
 Sample Date: 2/22/19 ✓ Static Press (in H₂O)
 Baro. Press (in Hg): 29.85 ✓
 Operator: M.J. WENZEL ✓ Ambient Temp (°F): 60

Stack Conditions
 Assumed: #2
 Actual:
 Meter Temp (°F): 65.55
 Static Press (in H₂O): -0.70
 Ambient Temp (°F): 60

Meter Box ID: 12
 Meter Box Y: 1.0069 ✓
 Meter Box Del H: 1.8212
 Probe ID / Length: P 695 5
 Probe Material: Boro
 Pitot / Thermocouple ID: P 695
 Pitot Coefficient: 0.84 ✓
 Nozzle ID: G160
 Nozzle Measurements: 0.160 0.160 0.160
 Avg Nozzle Dia (in): 0.160 ✓
 Area of Stack (ft²): 7.07 ✓
 Sample Time: 96 ✓
 Total Traverse Pts: 12 ✓

K Factor: 0.707

Initial	Mid-Point	Final
0.001	0.001	0.001
2.15	2.5	2.6
yes / no	yes / no	yes / no
yes / no	yes / no	yes / no
yes / no	yes / no	yes / no

Temp Check
 Meter Box Temp: MP 2.8 50
 Reference Temp: 50
 Pass/Fail (+/- 2°): Pass / Fall
 Temp Change Response: yes / no

TRAVERSE POINT	NO.	SAMPLE TIME (min)	CLOCK TIME (plant time)	VELOCITY PRESSURE Delta P (in H ₂ O)	ORIFICE PRESSURE Delta H (in H ₂ O)	DRY GAS METER READING (ft ³)	STACK TEMP (°F)	DGM OUTLET TEMP (°F)	PROBE TEMP (°F)	FILTER BOX TEMP (F)	IMPINGER EXIT TEMP (°F)	SAMPLE TRAIN VAC (in Hg)	XAD EXIT TEMP (F)	COMMENTS
		0	0823 ✓			5.851								
A	1	4		1.4	0.98	8.05	69	53	100	99	52	4	52	
	1	8		1.4	0.98	10.15	69	53	100	100	52	4	52	
	2	12		1.6	1.13	12.45	69	54	100	99	42	3	52	
	2	16		1.6	1.13	14.71	69	54	100	100	42	3	52	25.970
	3	20		1.8	1.27	17.01	69	55	101	101	41	3	41	
	3	24		1.8	1.27	19.45	69	55	101	101	41	4	41	
	4	28		1.7	1.20	21.71	69	56	100	103	41	4	41	
	4	32		1.7	1.20	23.92	69	56	100	103	41	4	41	
	5	36		1.3	0.91	26.00	69	57	100	99	42	3	42	
	5	40		1.3	0.91	28.01	69	57	100	99	42	3	42	
	6	44		1.1	0.77	29.91	69	59	100	101	43	2	43	
	6	48	0911	1.1	0.77	31.821	69	59	100	101	43	2	43	
			0930			31.945								
B	1	4		1.4	0.86	34.00	70	60	102	105	49	2	41	k-factor 0.619
	1	8		1.4	0.86	35.93	70	60	102	105	49	2	41	
	2	12		1.6	0.99	38.84	71	61	101	102	49	4	41	
	2	16		1.6	0.99	40.82	71	61	101	102	49	4	41	24.700
	3	20		1.8	1.11	42.81	71	61	101	101	48	4	41	
	3	24		1.8	1.11	45.10	71	61	101	101	48	4	41	
	4	28		1.7	1.05	46.98	70	62	101	101	48	4	42	
	4	32		1.7	1.05	49.72	70	62	101	101	48	4	42	
	5	36		1.4	0.86	51.18	71	64	100	100	48	3	42	
	5	40		1.4	0.86	53.13	71	64	100	100	48	3	42	
	6	44		1.0	0.61	54.89	71	66	99	100	49	2	44	
	6	48	1018 ✓	1.0	0.61	56.045	71	66	100	100	49	2	44	
				Avg Delta P	Avg Delta H	Total Volume	Avg T _s	Avg T _m	Min/Max	Min/Max	Max	Max Vac	Min/Max	
				1.48333	0.97833	50.670	69.8	59.0	99/102	99/105	52	4	41/52	
				Avg Sqrt Delta P	Avg Sqrt Del H	Comments:								
				1.21329	0.98465									



V. WAD

(Feedrate ISO - Burnout)

ISOKINETIC FIELD DATA SHEET

EPA Method 0010 - HFPO Dimer Acid

Client Chemours
 W.O.# 15418
 Project ID Chemours % Moisture
 Mode/Source ID Division Impinger Vol (ml)
 Samp. Loc. ID STK Silica gel (g)
 Run No. ID 6 CO2, % by Vol
 Test Method ID M0010 O2, % by Vol
 Date ID 25FEB2019 Temperature (°F)
 Source/Location Division Stack Meter Temp (°F)
 Sample Date 2/28/19 Static Press (in H₂O)
 Baro. Press (in Hg) 29.35
 Operator MPJWALKER Ambient Temp (°F)

Stack Conditions

Assumed	Actual
2.0	
0.1	✓
20.8	✓
68	
-0.10	
70	

Meter Box ID 12
 Meter Box Y 1.0069 ✓
 Meter Box Del H 1.8812
 Probe ID / Length 695 | 5
 Probe Material Boro
 Pitot / Thermocouple ID 695
 Pitot Coefficient 0.84 ✓
 Nozzle ID 6-160
 Nozzle Measurements 0.160 | 0.160 | 0.160
 Avg Nozzle Dia (in) 0.160 ✓
 Area of Stack (ft²) 7.07 ✓
 Sample Time 96 ✓
 Total Traverse Pts MPJWALKER | 12 ✓

K Factor 0.707

Initial	Mid-Point	Final
0.001	0.001	0.001
0.15	0.5	0.6
yes / no	yes / no	yes / no
yes / no	yes / no	yes / no
yes / no	yes / no	yes / no
Pre-Test Set		Post-Test Set
68		66
69		66
Pass / Fail		Pass / Fail
yes / no		yes / no

(Feedrate ISO - Burnout)

TRAVERSE POINT NO.	SAMPLE TIME (min)	CLOCK TIME (plant time)	VELOCITY PRESSURE Delta P (in H ₂ O)	ORIFICE PRESSURE Delta H (in H ₂ O)	DRY GAS METER READING (ft ³)	STACK TEMP (°F)	DGM OUTLET TEMP (°F)	PROBE TEMP (°F)	FILTER BOX TEMP (°F)	IMPINGER EXIT TEMP (°F)	SAMPLE TRAIN VAC (in Hg)	XAD EXIT TEMP (°F)	COMMENTS
ⓐ	0	1429 ✓			52.162								
1	4		1.4	0.98	60.30	76	68	100	100	66	3	67	
1	8		1.4	0.98	63.10	76	68	100	101	66	3	67	
2	12		1.9	1.34	64.52	76	68	100	101	65	4	65	26.87
2	16		1.9	1.34	67.00	76	68	100	101	65	4	65	
3	20		1.9	1.34	70.30	76	70	100	101	64	4	64	
3	24		1.9	1.34	72.50	76	71	102	102	64	4	64	
4	28		1.9	1.34	74.75	76	71	103	100	60	4	60	
4	32		1.8	1.27	77.00	76	72	103	99	59	4	53	
5	36		1.4	0.98	79.28	76	70	100	100	57	2	52	
5	40		1.4	0.98	81.35	76	70	100	100	57	2	52	
6	44		1.0	0.70	83.19	77	71	100	100	57	2	52	
6	48	1517	1.0	0.70	85.035	77	71	100	100	57	2	52	
ⓑ		1539			85.135								
1	4		1.4	0.98	87.31	76	70	100	100	63	3	59	
1	8		1.4	0.98	89.56	76	70	100	100	63	3	59	
2	12		1.8	1.27	91.86	76	70	100	100	63	3	58	27.005
2	16		1.8	1.27	94.22	76	70	100	100	63	3	58	
3	20		1.9	1.34	96.72	76	70	100	100	63	4	60	
3	24		1.9	1.34	99.15	76	70	100	100	63	4	60	
4	28		1.8	1.27	101.66	76	69	100	100	63	4	60	
4	32		1.8	1.27	104.26	76	69	100	100	63	4	60	
5	36		1.4	0.98	106.24	76	69	100	100	64	3	60	
5	40		1.4	0.98	102.01	76	69	100	99	63	3	62	
6	44		1.0	0.70	110.17	76	69	100	101	65	2	63	
6	48	1627 ✓	1.0	0.70	112.140	76	69	100	101	65	2	63	

Avg Delta P	Avg Delta H	Total Volume	Avg Ts	Avg Tr	Min/Max	Min/Max	Max	Max Vac	Min/Max
1.56250	1.09875	53.875	76	69.6	101/100	99/101	60	4	52/67
Avg Sqrt Delta P	Avg Sqrt Del H	Comments:							
1.24262	1.04184								



✓
anna

SAMPLE RECOVERY FIELD DATA

EPA Method 0010 - HFPO Dimer Acid

Client Chemours W.O. # 15418
 Location/Plant Fayetteville, NC Source & Location Division Stack

Run No. 4 Sample Date 2/27/19 Recovery Date 2/27/19
 Sample I.D. Chemours - Gas - STK - 4 - M0010 - Analyst RMM Filter Number NA

Impinger										
	1	2	3	4	5	6	7	Imp.Total	8	Total
Contents	Empty	HPLC H2O	HPLC H2O						Silica Gel	
Final	1	102	100	11					316.5	
Initial	0	100	100	0					300	
Gain	1	2	0	11				14	16.5	

Impinger Color clear Labeled?
 Silica Gel Condition Good Sealed?

Run No. 5 Sample Date 2/28/19 Recovery Date 2/28/19
 Sample I.D. Chemours - Gas - STK - 5 - M0010 - Analyst RMM Filter Number NA

Impinger										
	1	2	3	4	5	6	7	Imp.Total	8	Total
Contents	Empty	HPLC H2O	HPLC H2O						Silica Gel	
Final	1	101	100						313.1	
Initial	0	100	100	0					300	
Gain	1	1	0	1				3	13.1	

Impinger Color clear Labeled?
 Silica Gel Condition Good Sealed?

Run No. 6 Sample Date 2/28/19 Recovery Date 2/28/19
 Sample I.D. Chemours - Gas - STK - 6 - M0010 - Analyst RMM Filter Number NA

Impinger										
	1	2	3	4	5	6	7	Imp.Total	8	Total
Contents	Empty	HPLC H2O	HPLC H2O						Silica Gel	
Final	1	107	96	3					314.5	
Initial	0	100	100	0					300	
Gain	1	7	-4	3				7	14.5	

Impinger Color clear Labeled?
 Silica Gel Condition Good Sealed?

Check COC for Sample IDs of Media Blanks



CHEMOURS - FAYETTEVILLE, NC
INPUTS FOR HFPO DIMER ACID CALCULATIONS
DIVISION STACK

Test Data

Run number	7	8
Location	Divison Stack	Divison Stack
Date	3/01/19	3/01/19
Time period	0813-1008	1237-1433
Operator	MW	MW

Inputs For Calcs.

Sq. rt. delta P	1.23598	1.24646
Delta H	1.0832	1.0996
Stack temp. (deg.F)	65.6	71.3
Meter temp. (deg.F)	53.9	64.9
Sample volume (act.)	52.282	53.575
Barometric press. (in.Hg)	29.99	29.99
Volume H ₂ O imp. (ml)	3.0	10.0
Weight change sil. gel (g)	13.9	14.9
% CO ₂	0.1	0.1
% O ₂	20.8	20.8
% N ₂	79.1	79.1
Area of stack (sq.ft.)	7.070	7.070
Sample time (min.)	96.0	96.0
Static pressure (in.H ₂ O)	-0.70	-0.70
Nozzle dia. (in.)	0.160	0.160
Meter box cal.	1.0069	1.0069
Cp of pitot tube	0.84	0.84
Traverse points	12	12

ISOKINETIC FIELD DATA SHEET

EPA Method 0010 - HFPO Dimer Acid

Client Chemours
 W.O.# 15418
 Project ID Chemours % Moisture
 Mode/Source ID Division Impinger Vol (ml)
 Samp. Loc. ID STK Silica gel (g)
 Run No. ID 7 CO2, % by Vol
 Test Method ID M0010 O2, % by Vol
 Date ID 25FEB2019 Temperature (°F)
 Source/Location Division Stack Meter Temp (°F)
 Sample Date 2/01/19 ✓ Static Press (In H2O)
 Baro. Press (in Hg) 29.99 ✓
 Operator M. W. Neelen ✓ Ambient Temp (°F)

Stack Conditions	
Assumed	Actual
<u>2.0</u>	
<u>0.1</u> ✓	
<u>20.3</u> ✓	
<u>69</u>	
<u>-0.70</u> ✓	
<u>246</u>	

Meter Box ID 12
 Meter Box Y 1.0069 ✓
 Meter Box Del H 1.2812
 Probe ID / Length 695 / 5"
 Probe Material Boro
 Pitot / Thermocouple ID P695
 Pitot Coefficient 0.84
 Nozzle ID G160
 Nozzle Measurements 0.160 / 0.160 / 0.160
 Avg Nozzle Dia (in) 0.160 ✓
 Area of Stack (ft²) 7.07 ✓
 Sample Time 96 ✓
 Total Traverse Pts 12 ✓

Sample Train (ft³)
 Leak Check @ (In Hg)
 Pitot leak check good
 Pitot Inspection good
 Method 3 System good
Temp Check
 Meter Box Temp
 Reference Temp
 Pass/Fail (+/- 2°)
 Temp Change Response

K Factor <u>0.707</u>		
Initial	Mid-Point	Final
<u>0.001</u>	<u>0.001</u>	<u>0.001</u>
<u>2/5</u>	<u>2/5</u>	<u>2/6</u>
yes / no	yes / no	yes / no
yes / no	yes / no	yes / no
yes / no	yes / no	yes / no
Pre-Test Set		Post-Test Set
<u>50</u>		<u>56</u>
<u>50</u>		<u>56</u>
Pass / Fail		Pass / Fail
yes / no		yes / no

TRAVERSE POINT	NO.	SAMPLE TIME (min)	CLOCK TIME (plant time)	VELOCITY PRESSURE Delta P (in H2O)	ORIFICE PRESSURE Delta H (in H2O)	DRY GAS METER READING (ft³)	STACK TEMP (°F)	DGM OUTLET TEMP (°F)	PROBE TEMP (°F)	FILTER BOX TEMP (F)	IMPINGER EXIT TEMP (oF)	SAMPLE TRAIN VAC (in Hg)	XAD EXIT TEMP (F)	COMMENTS
ⓐ	1	0	0813 ✓			112.435								
	1	4		1.2	0.848	114.40	67	50	105	105	44	4	44	
	1	8		1.2	0.848	116.32	67	50	101	101	44	3	44	
	2	12		1.5	1.06	118.46	66	51	101	101	44	3	44	25.555
	2	14		1.5	1.06	120.55	66	51	101	101	44	3	44	
	3	20		1.7	1.20	122.20	66	52	101	101	50	4	50	
	3	24		1.7	1.20	125.05	66	52	101	104	50	4	50	
	4	28		1.8	1.27	127.44	65	50	101	104	52	4	52	
	4	32		1.8	1.27	129.76	65	50	101	104	52	4	52	
	5	36		1.5	1.06	131.97	65	51	102	104	52	3	52	
	5	40		1.5	1.06	134.10	65	51	102	104	52	3	52	
	6	44		1.2	0.84	136.04	64	51	100	100	52	2	52	
	6	48	0901	1.2	0.84	137.990	64	51	100	100	52	2	52	
			0920			138.128								
ⓑ	1	4		1.5	1.05	140.25	65	54	101	101	52	4	52	K-MAN
	1	8		1.5	1.05	142.36	65	54	101	101	44	4	44	0.700
	2	12		1.7	1.19	144.75	67	55	101	101	43	4	43	0.700
	2	16		1.7	1.19	146.88	67	55	101	101	43	4	43	
	3	20		2.0	1.40	149.38	65	55	101	101	43	4	42	26.727
	3	24		2.0	1.40	151.88	65	55	100	99	43	5	42	
	4	28		1.9	1.33	154.35	66	57	100	100	44	5	44	
	4	32	MW	1.9	1.33	156.87	65	58	101	102	44	5	44	
	5	36	1.5	1.9	1.33	159.02	65	58	101	102	44	4	44	
	5	40		1.5	1.05	161.25	66	58	102	102	45	4	45	
	6	44		1.0	0.70	163.60	66	59	100	100	45	3	45	
	6	48	1008 ✓	1.0	0.70	164.855	66	59	100	100	45	3	45	

Avg Delta P	Avg Delta H	Total Volume	Avg Ts	Avg Tm	Min/Max	Min/Max	Max	Max Vac	Min/Max
1.54167	1.08250	52.282	65.6	53.6	100/103	99/103	52	4	42/53
Avg Sqrt Delta P	Avg Sqrt Del H	Comments:							
1.23598	1.03566	* 1.5 ΔH is 1.05	53.8						

V
ama



(Feedrate @ 150 Burnout)

ISOKINETIC FIELD DATA SHEET

EPA Method 0010 - HFPO Dimer Acid

Client Chemours
 W.O.# 15418
 Project ID Chemours % Moisture
 Mode/Source ID Division Impinger Vol (ml)
 Samp. Loc. ID STK Silica gel (g)
 Run No. ID 8 CO2, % by Vol
 Test Method ID M0010 O2, % by Vol
 Date ID 25FEB2019 Temperature (°F)
 Source/Location Division Stack Meter Temp (°F)
 Sample Date 3/01/19 V Static Press (in H2O)
 Baro. Press (in Hg) 29.99 V
 Operator M. WINKLER V Ambient Temp (°F) ≈ 54

Stack Conditions
 Assumed 22.0
 Actual
 Meter Box ID 12
 Meter Box Y 1.0069
 Meter Box Del H 1.3812
 Probe ID / Length 695 / 5
 Probe Material Boro
 Pitot / Thermocouple ID P 695
 Pitot Coefficient 0.84 V
 Nozzle ID G160
 Nozzle Measurements 0.160 0.160 0.160
 Avg Nozzle Dia (in) 0.160 V
 Area of Stack (ft²) 7.07 V
 Sample Time 96 V
 Total Traverse Pts 12 V

K Factor 0.700
 Initial Mid-Point Final
 0.001 0.001 0.001
 Leak Check @ (in Hg) 0.15 0.6 0.6
 Pitot leak check good Yes / no Yes / no Yes / no
 Pitot inspection good Yes / no Yes / no Yes / no
 Method 3 System good Yes / no yes / no yes / no
 Temp Check
 Meter Box Temp 52
 Reference Temp 53
 Pass/Fall (+/- 2°) Pass / Fail Pass / Fail
 Temp Change Response? Yes / no yes / no

(Feed Rate - 150 Burnout)

TRAVERSE POINT	SAMPLE NO.	CLOCK TIME (plant time)	VELOCITY PRESSURE Delta P (in H2O)	ORIFICE PRESSURE Delta H (in H2O)	DRY GAS METER READING (ft³)	STACK TEMP (°F)	DGM OUTLET TEMP (°F)	PROBE TEMP (°F)	FILTER BOX TEMP (F)	IMPINGER EXIT TEMP (°F)	SAMPLE TRAIN VAC (in Hg)	XAD EXIT TEMP (F)	COMMENTS
	0	1237 V			165.000								
(A)	1	4	1.4	0.98	167.01	70	58	102	103	52	4	50	
	1	8	1.4	0.98	169.02	70	58	102	103	52	4	50	
	2	12	1.6	1.12	171.49	70	59	103	102	46	4	45	26.630
	2	16	1.6	1.12	173.72	70	59	103	102	46	4	45	
	3	20	1.8	1.26	176.04	70	60	101	101	45	4	43	
	3	24	1.8	1.26	178.30	70	60	101	102	45	4	42	
	4	28	2.0	1.40	180.80	71	60	101	102	45	5	42	
	4	32	2.1	1.47	183.62	71	61	102	99	45	4	42	
	5	36	1.5	1.05	185.59	71	63	100	104	46	4	43	
	5	40	1.5	1.05	187.73	71	63	100	100	46	4	43	
	6	44	1.1	0.77	189.62	71	64	100	100	47	3	44	
	6	48	1.1	0.77	191.630	71	64	100	99	47	3	44	
		1325			191.755								
		1345											
(B)	1	4	1.5	1.05	193.91	72	67	102	105	47	3	44	
	1	8	1.5	1.05	196.05	72	67	102	105	47	3	44	26.943
	2	12	1.8	1.26	198.40	72	67	100	99	51	4	44	
	2	16	1.8	1.26	200.81	72	69	101	99	51	4	45	
	3	20	2.0	1.40	203.27	73	69	101	99	52	4	45	
	3	24	2.0	1.40	205.76	73	69	101	102	52	4	46	
	4	28	1.4	0.98	208.10	73	69	101	102	52	3	46	
	4	32	2.0	1.40	210.72	73	69	101	102	52	3	47	
	5	36	1.4	0.98	212.92	72	70	100	100	53	3	48	
	5	40	1.4	0.98	215.00	72	70	100	99	53	3	48	
	6	44	1.0	0.70	216.82	71	71	100	100	54	2	49	
	6	48	1.0	0.70	218.700	71	71	100	100	54	2	49	

Avg Delta P V 1.57083
 Avg Delta H V 1.09958
 Total Volume 53.575
 Avg Ts V 71.3
 Avg Tm V 64.9
 Min/Max 100/103
 Min/Max 99/105
 Max 54
 Max Vac 5
 Min/Max 42/50
 Comments: ? Flow rate change M. W. B/01/19



SAMPLE RECOVERY FIELD DATA

EPA Method 0010 - HFPO Dimer Acid

Client Chemours W.O. # 15418
 Location/Plant Fayetteville, NC Source & Location Division Stack

Run No. 7 Sample Date 3/1/19 Recovery Date 3/1/19
 Sample I.D. Chemours - Gas - STK - 7 - M0010 - Analyst ADMM Filter Number NA

Impinger										
	1	2	3	4	5	6	7	Imp.Total	8	Total
Contents	Empty	HPLC H2O	HPLC H2O						Silica Gel	
Final	<u>2</u>	<u>97</u>	<u>103</u>	<u>1</u>					<u>313.9</u>	
Initial	<u>0</u>	100	100	<u>0</u>					300	
Gain	<u>2</u>	<u>-3</u>	<u>3</u>	<u>1</u>				<u>3</u> ✓	<u>13.9</u> ✓	<u>16.9</u>

Impinger Color clear Labeled?
 Silica Gel Condition Good Sealed?

Run No. 8 Sample Date 3/1/19 Recovery Date 3/1/19
 Sample I.D. Chemours - Gas - STK - 8 - M0010 - Analyst ADMM Filter Number NA

Impinger										
	1	2	3	4	5	6	7	Imp.Total	8	Total
Contents	Empty	HPLC H2O	HPLC H2O						Silica Gel	
Final	<u>8</u>	<u>100</u>	<u>100</u>	<u>2</u>					<u>312.9</u>	
Initial	<u>0</u>	100	100	<u>0</u>					300	
Gain	<u>8</u>	<u>0</u>	<u>0</u>	<u>2</u>				<u>10</u> ✓	<u>12.9</u> ✓	<u>24.9</u>

Impinger Color clear Labeled?
 Silica Gel Condition Good Sealed?

Run No. Sample Date Recovery Date
 Sample I.D. Chemours - Gas - STK - 0 - M0010 - Analyst Filter Number

Impinger										
	1	2	3	4	5	6	7	Imp.Total	8	Total
Contents	Empty	HPLC H2O	HPLC H2O						Silica Gel	
Final										
Initial		100	100						300	
Gain										

Impinger Color Labeled?
 Silica Gel Condition Sealed?

Check COC for Sample IDs of Media Blanks



CHEMOURS - FAYETTEVILLE, NC
INPUTS FOR HFPO DIMER ACID CALCULATIONS
BLOWER INTAKE

Test Data

Run number	1	2	3
Location	Blower Intake	Blower Intake	Blower Intake
Date	2/26/19	2/26/19	2/27/19
Time period	0927-1143	1335-1530	0840-1035
Operator	JM	JM	JM

Inputs For Calcs.

Delta H	3.0000	3.0000	3.0000
Stack temp. (deg.F)	59.9	68.4	60.3
Meter temp. (deg.F)	60.4	78.3	65.1
Sample volume (act.)	128.621	109.397	107.605
Barometric press. (in.Hg)	29.29	30.20	30.22
Volume H ₂ O imp. (ml)	0.0	0.0	7.0
Weight change sil. gel (g)	27.6	27.5	22.4
% CO ₂	0.0	0.0	0.0
% O ₂	20.9	20.9	20.9
% N ₂	79.1	79.1	79.1
Sample time (min.)	135.0	115.0	115.0
Nozzle dia. (in.)	0.365	0.365	0.365
Meter box cal.	1.0100	1.0100	1.0100
Traverse points	1	1	1

ISOKINETIC FIELD DATA SHEET

EPA Method 0010 - HFPO Dimer Acid

Client Chemours
W.O.# 15418.002.010.0001
Project ID Chemours
Mode/Source ID Blower Intake % Moisture
Samp. Loc. ID Intake Silica gel (g)
Run No. ID 1 CO2, % by Vol
Test Method ID M0010 O2, % by Vol
Date ID 25FEB2019 Temperature (°F)
Source/Location Blower Intake Meter Temp (°F)
Sample Date 2/26/19 ✓ Static Press (in H2O)
Baro. Press (in Hg) 29.29 ✓
Operator Mills ✓ Ambient Temp (°F)

Stack Conditions		Assumed	Actual

Meter Box ID MC29
Meter Box Y 1.0100 ✓
Meter Box Del H 1.9363
Probe ID / Length 31
Probe Material Boro
Pitot / Thermocouple ID NA
Pitot Coefficient NA
Nozzle ID 0.84
Nozzle Measurements
Avg Nozzle Dia (in)
Area of Stack (ft²)
Sample Time
Total Traverse Pts ONE ✓

K Factor		
Initial	Mid-Point	Final
<u>0.002</u>		<u>0.002</u>
<u>15</u>		<u>11</u>
Leak Check @ (In Hg)		
Pitot leak check good <u>NA</u>	yes / no	yes / no
Pitot inspection good <u>NA</u>	yes / no	yes / no
Method 3 System good <u>NA</u>	yes / no	yes / no
Temp Check		
Pre-Test Set	Post-Test Set	
Meter Box Temp <u>52</u>		<u>61</u>
Reference Temp <u>51</u>		<u>62</u>
Pass/Fail (+/- 2°)	Pass / Fail	Pass / Fail
Temp Change Response <u>yes</u>	yes / no	yes / no

TRAVERSE POINT NO.	SAMPLE TIME (min)	CLOCK TIME (plant time)	VELOCITY PRESSURE Delta P (in H2O)	ORIFICE PRESSURE Delta H (in H2O)	DRY GAS METER READING (ft³)	STACK TEMP (°F)	DGM OUTLET TEMP (°F)	PROBE TEMP (°F)	FILTER BOX TEMP (F)	IMPINGER EXIT TEMP (oF)	SAMPLE TRAIN VAC (in Hg)	XAD EXIT TEMP (F)	COMMENTS
0					<u>156.015</u>								
5		<u>09:27</u> ✓	<u>NA</u>	<u>3.0</u>	<u>161.7</u>	<u>52</u>	<u>49</u>	<u>117</u>	<u>113</u>	<u>44</u>	<u>8</u>	<u>41</u>	
10				<u>3.0</u>	<u>166.5</u>	<u>53</u>	<u>50</u>	<u>108</u>	<u>116</u>	<u>39</u>	<u>8</u>	<u>40</u>	
15				<u>3.0</u>	<u>171.5</u>	<u>54</u>	<u>51</u>	<u>110</u>	<u>114</u>	<u>42</u>	<u>8</u>	<u>40</u>	
20				<u>3.0</u>	<u>176.3</u>	<u>53</u>	<u>52</u>	<u>121</u>	<u>113</u>	<u>50</u>	<u>8</u>	<u>41</u>	
25				<u>3.0</u>	<u>181.1</u>	<u>54</u>	<u>55</u>	<u>122</u>	<u>114</u>	<u>50</u>	<u>8</u>	<u>44</u>	
30				<u>3.0</u>	<u>185.9</u>	<u>55</u>	<u>56</u>	<u>124</u>	<u>114</u>	<u>50</u>	<u>8</u>	<u>45</u>	
35				<u>3.0</u>	<u>190.4</u>	<u>56</u>	<u>56</u>	<u>125</u>	<u>115</u>	<u>47</u>	<u>8</u>	<u>42</u>	
40				<u>3.0</u>	<u>195.1</u>	<u>56</u>	<u>58</u>	<u>122</u>	<u>114</u>	<u>47</u>	<u>8</u>	<u>40</u>	
45				<u>3.0</u>	<u>199.7</u>	<u>56</u>	<u>59</u>	<u>121</u>	<u>115</u>	<u>48</u>	<u>8</u>	<u>41</u>	
50				<u>3.0</u>	<u>204.8</u>	<u>58</u>	<u>60</u>	<u>120</u>	<u>115</u>	<u>50</u>	<u>8</u>	<u>41</u>	
55				<u>3.0</u>	<u>209.3</u>	<u>59</u>	<u>61</u>	<u>117</u>	<u>119</u>	<u>49</u>	<u>8</u>	<u>41</u>	
60				<u>3.0</u>	<u>214.5</u>	<u>59</u>	<u>62</u>	<u>114</u>	<u>114</u>	<u>49</u>	<u>8</u>	<u>40</u>	
65				<u>3.0</u>	<u>218.6</u>	<u>60</u>	<u>62</u>	<u>113</u>	<u>114</u>	<u>50</u>	<u>8</u>	<u>41</u>	
70				<u>3.0</u>	<u>223.1</u>	<u>61</u>	<u>63</u>	<u>114</u>	<u>114</u>	<u>50</u>	<u>8</u>	<u>40</u>	
75				<u>3.0</u>	<u>227.8</u>	<u>60</u>	<u>64</u>	<u>115</u>	<u>115</u>	<u>51</u>	<u>8</u>	<u>41</u>	
80				<u>3.0</u>	<u>233.0</u>	<u>62</u>	<u>64</u>	<u>116</u>	<u>114</u>	<u>52</u>	<u>8</u>	<u>40</u>	
85	<u>10:55</u>			<u>3.0</u>	<u>237.6</u>	<u>62</u>	<u>64</u>	<u>115</u>	<u>113</u>	<u>52</u>	<u>8</u>	<u>41</u>	
90				<u>3.0</u>	<u>242.2</u>	<u>65</u>	<u>65</u>	<u>116</u>	<u>114</u>	<u>52</u>	<u>8</u>	<u>42</u>	
1:35				<u>3.0</u>	<u>247.8</u>	<u>64</u>	<u>66</u>	<u>117</u>	<u>114</u>	<u>53</u>	<u>8</u>	<u>41</u>	
1:40				<u>3.0</u>	<u>251.5</u>	<u>64</u>	<u>67</u>	<u>118</u>	<u>114</u>	<u>54</u>	<u>8</u>	<u>41</u>	
1:45				<u>3.0</u>	<u>256.0</u>	<u>64</u>	<u>67</u>	<u>118</u>	<u>114</u>	<u>54</u>	<u>8</u>	<u>42</u>	
1:50				<u>3.0</u>	<u>260.6</u>	<u>65</u>	<u>68</u>	<u>118</u>	<u>114</u>	<u>54</u>	<u>8</u>	<u>42</u>	
1:55				<u>3.0</u>	<u>265.8</u>	<u>66</u>	<u>68</u>	<u>119</u>	<u>114</u>	<u>54</u>	<u>8</u>	<u>42</u>	
2				<u>3.0</u>	<u>270.4</u>	<u>64</u>	<u>68</u>	<u>118</u>	<u>113</u>	<u>54</u>	<u>8</u>	<u>42</u>	

Avg Delta P	Avg Delta H	Total Volume	Avg Ts	Avg Tm	Min/Max	Min/Max	Max	Max Vac	Min/Max
Avg Sqrt Delta P	Avg Sqrt Del H	Comments:							



EPA Method 0010 from EPA SW-846

Handwritten signature/initials

ISOKINETIC FIELD DATA SHEET

EPA Method 0010 - HFPO Dimer Acid

Client Chemours Operator
 Source Blower Intake Run No.
 Sample Loc. Date *Mills*
1 *2/26/19*

K Factor

TRAVERSE POINT NO.	SAMPLE TIME (min)	CLOCK TIME (plant time)	VELOCITY PRESSURE Delta P (in H2O)	ORIFICE PRESSURE Delta H (in H2O)	DRY GAS METER READING (ft ³)	STACK TEMP (°F)	DGM OUTLET TEMP (°F)	PROBE TEMP (°F)	FILTER BOX TEMP (F)	IMPING EXIT TEMP (°F)	SAMPLE TRAIN VAC (in Hg)	XAD EXIT TEMP (F)	COMMENTS
	0				270.4								
	2:05		NA	3.0	275.2	65	69	119	115	56	8	43	
	2:10			3.0	279.9	65	71	117	112	57	8	42	
	2:15	1143 ↓		3.0	284.6	64	71	120	112	56	8	42	

Avg Delta P	Avg Delta H	Total Volume	Avg Ts	Avg Tm	Min/Max	Min/Max	Max Temp	Max Vac	Max Temp
Avg Sqrt Delta P	Avg Sqrt Del H	Comments:							



amad

ISOKINETIC FIELD DATA SHEET

EPA Method 0010 - HFPO Dimer Acid

Client Chemours
W.O.# 15418.002.010.0001
Project ID Chemours % Moisture
Mode/Source ID Blower Intake Impinger Vol (ml)
Samp. Loc. ID Intake Silica gel (g)
Run No. ID 2 CO2, % by Vol
Test Method ID M0010 O2, % by Vol
Date ID 25FEB2019 Temperature (°F)
Source/Location Blower Intake Meter Temp (°F)
Sample Date 2/26/19 Static Press (In H2O)
Baro. Press (in Hg) 30.20
Operator Mills Ambient Temp (°F)

Stack Conditions	
Assumed	Actual

Meter Box ID WC29
Meter Box Y 1.0100
Meter Box Del H 3'
Probe ID / Length 19363
Probe Material Boro
Pitot / Thermocouple ID NA
Pitot Coefficient NA
Nozzle ID
Nozzle Measurements
Avg Nozzle Dia (in)
Area of Stack (ft²)
Sample Time ONE
Total Traverse Pts

K Factor		
Initial	Mid-Point	Final
<u>0.002</u>		<u>0.002</u>
<u>15</u>		<u>8</u>
<u>NA</u>		<u>NA</u>
<u>NA</u>		<u>NA</u>
<u>NA</u>		<u>NA</u>
<u>70</u>		<u>70</u>
<u>71</u>		<u>75</u>
<u>Pass / Fail</u>		<u>Pass / Fail</u>
<u>yes / no</u>		<u>yes / no</u>

TRAVERSE POINT NO.	SAMPLE TIME (min)	CLOCK TIME (plant time)	VELOCITY PRESSURE Delta P (in H2O)	ORIFICE PRESSURE Delta H (in H2O)	DRY GAS METER READING (ft³)	STACK TEMP (°F)	DGM OUTLET TEMP (°F)	PROBE TEMP (°F)	FILTER BOX TEMP (°F)	IMPINGER EXIT TEMP (°F)	SAMPLE TRAIN VAC (in Hg)	XAD EXIT TEMP (°F)	COMMENTS
0		1325			284.810								
3			NA	3.0	284.4	67	75	129	113	65	8	62	
10				3.0	294.6	68	75	125	113	63	8	60	
15				3.0	298.9	67	75	114	114	63	8	57	
20				3.0	303.2	68	76	116	114	64	8	48	
25				3.0	308.6	68	77	115	114	56	8	42	
30				3.0	313.6	66	77	116	113	51	8	42	
35				3.0	318.4	67	78	123	114	51	8	43	
40				3.0	323.0	68	78	121	114	51	8	42	
45				3.0	327.8	68	78	122	113	50	8	43	
50				3.0	341.5	68	78	124	114	51	8	43	
55				3.0	337.2	67	78	124	114	51	8	43	
60				3.0	342.0	67	79	125	114	51	8	43	
1:05		1442 Resume		3.0	346.5	69	79	122	115	53	8	44	
1:10				3.0	351.2	68	79	123	114	53	8	44	
1:15				3.0	356.0	68	79	123	114	53	8	45	
1:20				3.0	360.6	70	79	126	115	54	8	46	
1:25				3.0	365.4	72	80	124	114	54	8	46	
1:30				3.0	370.4	69	80	125	113	54	8	46	
1:35				3.0	374.7	69	80	125	113	55	8	47	
1:40				3.0	379.5	68	80	126	114	54	8	46	
1:45				3.0	384.0	69	80	127	113	55	8	48	
1:50				3.0	388.7	69	80	127	113	56	8	48	
1:55				3.0	393.3	70	80	126	115	58	8	51	
1:56				3.0	394.207	71	80	127	115	60	8	53	



Avg Delta P	Avg Delta H	Total Volume	Avg Ts	Avg Tm	Min/Max	Min/Max	Max	Max Vac	Min/Max
Avg Sqrt Delta P	Avg Sqrt Del H	Comments:		EPA Method 0010 from EPA SW-846					

anna

SAMPLE RECOVERY FIELD DATA

EPA Method 0010 - HFPO Dimer Acid

Client Chemours W.O. # 15418.002.010.0001
 Location/Plant Fayetteville, NC Source & Location Blower Intake

Run No. 1 Sample Date 2/26/19 Recovery Date 2/26/19
 Sample I.D. Chemours - Blower Intake - Intake - 1 - M0010 - Analyst PMU Filter Number NA

	Impinger							Imp.Total	8	Total
	1	2	3	4	5	6	7			
Contents	Empty	HPLC H2O	HPLC H2O						Silica Gel	
Final	1	91	47	11					326	
Initial	0	100	100	0					300	
Gain	1	-9	-3	11				10	26	

Impinger Color Clear Labeled?
 Silica Gel Condition Good Sealed?

Run No. 2 Sample Date 2/26/19 Recovery Date 2/26/19
 Sample I.D. Chemours - Blower Intake - Intake - 2 - M0010 - Analyst PMU Filter Number NA

	Impinger							Imp.Total	8	Total
	1	2	3	4	5	6	7			
Contents	Empty	HPLC H2O	HPLC H2O						Silica Gel	
Final	2	89	99	10					325	
Initial	0	100	100	0					300	
Gain	2	-11	-1	10				0	25	

Impinger Color Clear Labeled?
 Silica Gel Condition Good Sealed?

Run No. 3 Sample Date 2/27/19 Recovery Date 2/27/19
 Sample I.D. Chemours - Blower Intake - Intake - 3 - M0010 - Analyst PMU Filter Number NA

	Impinger							Imp.Total	8	Total
	1	2	3	4	5	6	7			
Contents	Empty	HPLC H2O	HPLC H2O						Silica Gel	
Final	9	90	103	5					322.7	
Initial	0	100	100	0					300	
Gain	9	-10	3	5				7	22.7	

Impinger Color Clear Labeled?
 Silica Gel Condition Good Sealed?

Check COC for Sample IDs of Media Blanks



CHEMOURS - FAYETTEVILLE, NC
INPUTS FOR HFPO DIMER ACID CALCULATIONS
BLOWER INTAKE

Test Data

Run number	4	5	6
Location	Blower Intake	Blower Intake	Blower Intake
Date	2/27/19	2/28/19	2/28/19
Time period	1231-1426	0823-1018	1429-1627
Operator	JM	JM	JM

Inputs For Calcs.

Delta H	3.0000	3.0000	3.0000
Stack temp. (deg.F)	64.1	57.3	70.8
Meter temp. (deg.F)	73.6	63.4	81.8
Sample volume (act.)	106.883	106.308	110.497
Barometric press. (in.Hg)	30.17	29.95	29.95
Volume H ₂ O imp. (ml)	22.0	15.0	6.0
Weight change sil. gel (g)	23.9	25.7	30.4
% CO ₂	0.0	0.0	0.0
% O ₂	20.9	20.9	20.9
% N ₂	79.1	79.1	79.1
Sample time (min.)	115.0	115.0	118.0
Nozzle dia. (in.)	0.365	0.365	0.365
Meter box cal.	1.0100	1.0100	1.0100
Traverse points	1	1	1

ISOKINETIC FIELD DATA SHEET

EPA Method 0010 - HFPO Dimer Acid

Client: Chemours
 W.O.#: 15418.002.010.0001
 Project ID: Chemours
 Mode/Source ID: Blower Intake
 Samp. Loc. ID: Intake
 Run No. ID: 4
 Test Method ID: M0010
 Date ID: 25FEB2019
 Source/Location: Blower Intake
 Sample Date: 2/27/19
 Baro. Press (in Hg): 30.17
 Operator: Mills

Stack Conditions	
Assumed	Actual
0	20.9
70	

Meter Box ID: NC29
 Meter Box Y: 1.0100 ✓
 Meter Box Del H: 1.9363
 Probe ID / Length: 3'
 Probe Material: Boro
 Pitot / Thermocouple ID: NA
 Pitot Coefficient: 0.84
 Nozzle ID: NA
 Nozzle Measurements: NA
 Avg Nozzle Dia (in): NA
 Area of Stack (ft²): 115
 Sample Time: ONE ✓
 Total Traverse Pts: ONE ✓

Sample Train (ft³): NA
 Leak Check @ (in Hg): NA
 Pitot leak check good: NA
 Pitot Inspection good: NA
 Method 3 System good: NA
Temp Check
 Meter Box Temp: 65
 Reference Temp: 65
 Pass/Fail (+/- 2°): Pass / Fail
 Temp Change Response: yes / no

K Factor		
Initial	Mid-Point	Final
0.002		0.002
15		10
yes / no	yes / no	yes / no
yes / no	yes / no	yes / no
yes / no	yes / no	yes / no
yes / no	yes / no	yes / no
Pre-Test Set		Post-Test Set
65		67
65		67
Pass / Fail		Pass / Fail
yes / no		yes / no

TRAVERSE POINT NO.	SAMPLE TIME (min)	CLOCK TIME (plant time)	VELOCITY PRESSURE Delta P (in H2O)	ORIFICE PRESSURE Delta H (in H2O)	DRY GAS METER READING (ft³)	STACK TEMP (°F)	DGM OUTLET TEMP (°F)	PROBE TEMP (°F)	FILTER BOX TEMP (°F)	IMPINGER EXIT TEMP (°F)	SAMPLE TRAIN VAC (in Hg)	XAD EXIT TEMP (°F)	COMMENTS
0	123		NA	3.0	503.595	62	64	122	113	54	8	48	
5				3.0	508.2	62	69	120	113	45	8	42	
10				3.0	517.7	64	70	122	113	46	8	43	
15				3.0	512.3	64	70	124	113	48	8	44	
20				3.0	527.0	64	70	123	113	50	8	43	
25				3.0	531.8	64	70	123	113	51	8	43	
30				3.0	536.4	64	71	122	114	51	8	44	
35				3.0	541.0	64	72	121	114	52	8	44	
40				3.0	545.8	64	72	121	115	51	8	44	1319 Part 1/10
45				3.0	549.8	63	74	121	115	51	8	44	
50				3.0	553.0	64	74	121	115	51	8	43	
55				3.0	559.6	64	75	121	114	51	8	43	
60				3.0	564.4	64	75	122	113	52	8	42	1328 2nd Part 0/10
1:05				3.0	568.6	64	75	121	113	52	8	42	
1:10				3.0	573.5	64	75	121	115	52	8	43	
1:15				3.0	578.5	64	76	121	115	52	8	43	
1:20				3.0	582.7	64	76	122	113	52	8	43	
1:25				3.0	587.2	64	76	124	113	52	8	44	
1:30				3.0	592.2	65	76	124	114	54	8	44	
1:35				3.0	596.6	64	77	123	114	54	8	45	
1:40				3.0	601.2	65	77	123	114	56	8	47	
1:45				3.0	605.7	66	77	124	114	57	8	50	
1:50				3.0	610.478	66	77	123	114	58	8	51	
1:55				3.0									

115 MIN RUN



Avg Delta P	Avg Delta H	Total Volume	Avg Ts	Avg Tm	Min/Max	Min/Max	Max	Max Vac	Min/Max
Avg Sqrt Delta P	Avg Sqrt Del H	Comments:			EPA Method 0010 from EPA SW-846				

amcd

ISOKINETIC FIELD DATA SHEET

EPA Method 0010 - HFPO Dimer Acid

Client Chemours
 W.O.# 15418.002.010.0001
 Project ID Chemours
 Mode/Source ID Blower Intake
 Samp. Loc. ID Intake
 Run No. ID 5
 Test Method ID M0010
 Date ID 25FEB2019
 Source/Location Blower Intake
 Sample Date 2/28/19
 Baro. Press (in Hg) 29.95
 Operator Mills

Stack Conditions
 Assumed Actual
 % Moisture
 Impinger Vol (ml)
 Silica gel (g)
 CO2, % by Vol
 O2, % by Vol
 Temperature (°F)
 Meter Temp (°F)
 Static Press (in H2O)
 Ambient Temp (°F)

Meter Box ID WC29
 Meter Box Y 1.0100
 Meter Box Del H 1.9363
 Probe ID / Length 3'
 Probe Material Boro
 Pitot / Thermocouple ID
 Pitot Coefficient NA
 Nozzle ID -0.84
 Nozzle Measurements
 Avg Nozzle Dia (in)
 Area of Stack (ft²)
 Sample Time 115
 Total Traverse Pts ONE

K Factor
 Initial Mid-Point Final
 0.002 11 0.002
 Leak Check @ (in Hg) 14
 Pitot leak check good NA
 Pitot Inspection good NA
 Method 3 System good NA
Temp Check
 Pre-Test Set Post-Test Set
 Meter Box Temp 56 62
 Reference Temp 57 62
 Pass/Fail (+/- 2°) Pass / Fail Pass / Fail
 Temp Change Response yes / no yes / no

TRAVERSE POINT NO.	SAMPLE TIME (min)	CLOCK TIME (plant time)	VELOCITY PRESSURE Delta P (in H2O)	ORIFICE PRESSURE Delta H (in H2O)	DRY GAS METER READING (ft³)	STACK TEMP (°F)	DGM OUTLET TEMP (°F)	PROBE TEMP (°F)	FILTER BOX TEMP (°F)	IMPINGER EXIT TEMP (°F)	SAMPLE TRAIN VAC (in Hg)	XAD EXIT TEMP (°F)	COMMENTS
0		0623			610.647								
5			NA	3.0	615.3	55	57	126	114	49	8	44	
10				3.0	619.9	53	58	121	114	46	8	43	
15				3.0	624.4	53	59	115	113	48	8	42	
20				3.0	629.1	53	59	114	113	48	8	42	
25				3.0	633.6	56	60	114	113	50	8	42	
30				3.0	638.2	57	61	116	114	49	8	42	
35				3.0	642.9	57	62	116	114	49	8	42	
40				3.0	647.5	57	62	115	114	51	8	42	
45				3.0	652.2	57	63	116	114	52	8	43	
50				3.0	656.6	57	63	119	114	51	8	44	
55				3.0	661.1	57	64	120	115	51	8	43	0911 Part Change
60				3.0	665.6	58	64	118	115	51	8	43	
1:05				3.0	669.9	57	64	118	115	51	8	42	
1:10				3.0	675.0	58	65	118	114	51	8	42	0430 Part Change over
1:15				3.0	679.6	57	65	118	114	51	8	43	
1:20				3.0	684.3	58	66	119	115	52	8	43	
1:25				3.0	689.0	58	66	118	114	52	8	46	
1:30				3.0	693.7	58	66	118	114	52	8	44	
1:35				3.0	698.2	59	66	118	114	52	8	44	
1:40				3.0	702.5	59	67	119	115	54	8	46	
1:45				3.0	707.2	59	67	119	114	55	8	47	
1:50				3.0	711.9	59	67	119	114	55	8	48	
1:55				3.0	716.955	60	68	119	114	56	8	49	

1015
 Mills



Avg Delta P	Avg Delta H	Total Volume	Avg Ts	Avg Tm	Min/Max	Min/Max	Max	Max Vac	Min/Max
Avg Sqrt Delta P	Avg Sqrt Del H	Comments:							

AMMA

ISOKINETIC FIELD DATA SHEET

EPA Method 0010 - HFPO Dimer Acid

Page ___ of ___

Client: Chemours
 W.O.#: 15418.002.010.0001
 Project ID: Chemours
 Mode/Source ID: Blower Intake
 Samp. Loc. ID: Intake
 Run No. ID: 6
 Test Method ID: M0010
 Date ID: 25FEB2019
 Source/Location: Blower Intake
 Sample Date: 2/25/19
 Baro. Press (in Hg): 29.95
 Operator: M. HS

Stack Conditions

Assumed	Actual
0 ✓	
20.9 ✓	
74	

Meter Box ID: WCR9
 Meter Box Y: 1.0100 ✓
 Meter Box Del H: 1.9363
 Probe ID / Length: 31
 Probe Material: Boro
 Pitot / Thermocouple ID:
 Pitot Coefficient: NA - 0.84
 Nozzle ID:
 Nozzle Measurements: 3.65 ✓
 Avg Nozzle Dia (in): 3.65 ✓
 Area of Stack (ft²): 118 ✓
 Sample Time: ONE
 Total Traverse Pts:

K Factor: Initial 0.002, Mid-Point 16, Final 0.002
 Sample Train (ft³):
 Leak Check @ (In Hg): 16
 Pitot leak check good: NA
 Pitot Inspection good: NA
 Method 3 System good: NA
Temp Check
 Meter Box Temp: 73
 Reference Temp: 74
 Pass/Fail (+/- 2°): Pass / Fail
 Temp Change Response: yes / no

TRAVERSE POINT NO.	SAMPLE TIME (min)	CLOCK TIME (plant time)	VELOCITY PRESSURE Delta P (in H2O)	ORIFICE PRESSURE Delta H (in H2O)	DRY GAS METER READING (ft³)	STACK TEMP (°F)	DGM OUTLET TEMP (°F)	PROBE TEMP (°F)	FILTER BOX TEMP (°F)	IMPINGER EXIT TEMP (°F)	SAMPLE TRAIN VAC (in Hg)	XAD EXIT TEMP (°F)	COMMENTS
0	5	11:29	NA	3.0	717.133	70	78	124	113	67	9.0	64	
10	15		NA	3.0	721.8	71	78	120	113	57	9.0	52	
20	25		NA	3.0	731.3	72	78	120	113	57	9.0	50	
30	35		NA	3.0	735.7	71	79	119	113	59	9.0	51	
40	45		NA	3.0	740.2	72	79	119	113	59	9.0	52	
50	55		NA	3.0	745.3	72	80	119	113	61	9.0	53	
60	1:05		NA	3.0	749.7	70	80	120	115	62	9.0	53	
1:10	1:15		NA	3.0	751.5	72	81	119	114	62	9.0	52	
1:20	1:25		NA	3.0	759.3	73	82	119	113	62	9.0	52	
1:30	1:35		NA	3.0	763.9	71	82	118	113	62	9.0	53	1517
1:40	1:45		NA	3.0	768.6	72	82	119	114	62	9.0	54	Post intake
1:50	1:55		NA	3.0	773.0	71	82	119	114	63	9.0	54	
1:58			NA	3.0	777.8	70	83	118	114	63	9.0	55	
			NA	3.0	782.5	70	83	118	115	63	9.0	56	1539
			NA	3.0	787.0	70	83	117	114	63	9.0	52	
			NA	3.0	791.7	70	83	118	113	64	9.0	52	
			NA	3.0	796.5	71	84	119	113	64	9.0	53	
			NA	3.0	801.1	70	84	118	114	64	9.0	53	
			NA	3.0	805.8	71	84	118	113	64	9.0	53	
			NA	3.0	810.5	71	84	117	114	64	9.0	56	
			NA	3.0	814.9	70	84	117	113	64	9.0	56	
			NA	3.0	819.9	70	84	117	113	64	9.0	56	
			NA	3.0	824.7	69	84	116	113	65	9.0	57	
			NA	3.0	827.630	70	84	115	112	65	9.0	60	



118MM RW

Avg Delta P	Avg Delta H	Total Volume	Avg Ts	Avg Tm	Min/Max	Min/Max	Max	Max Vac	Min/Max
Avg Sqrt Delta P	Avg Sqrt Del H	Comments:							

EPA Method 0010 from EPA SW-846

anna

SAMPLE RECOVERY FIELD DATA

EPA Method 0010 - HFPO Dimer Acid

Client Chemours W.O. # 15418.002.010.0001
 Location/Plant Fayetteville, NC Source & Location Blower Intake

Run No. 4 Sample Date 2/27/19 Recovery Date 2/27/19
 Sample I.D. Chemours - Blower Intake - Intake - 4 - M0010 - Analyst PMU Filter Number NA

	Impinger							Imp.Total	8	Total
	1	2	3	4	5	6	7			
Contents	Empty	HPLC H2O	HPLC H2O						Silica Gel	
Final	16	88	100	10					323.9	
Initial	0	100	100	0					300	
Gain	16	~12	8	10				22	23.9	45.9

Impinger Color Clear Labeled?
 Silica Gel Condition Good Sealed?

Run No. 5 Sample Date 2/28/19 Recovery Date 2/28/19
 Sample I.D. Chemours - Blower Intake - Intake - 5 - M0010 - Analyst PMU Filter Number NA

	Impinger							Imp.Total	8	Total
	1	2	3	4	5	6	7			
Contents	Empty	HPLC H2O	HPLC H2O						Silica Gel	
Final	14	100	98	2					323.9	
Initial	0	100	100	0					300	
Gain	14	1	~2	2				15	13.9	40.7

Impinger Color Clear Labeled?
 Silica Gel Condition Good Sealed?

Run No. 6 Sample Date 2/28/19 Recovery Date 2/28/19
 Sample I.D. Chemours - Blower Intake - Intake - 6 - M0010 - Analyst PMU Filter Number NA

	Impinger							Imp.Total	8	Total
	1	2	3	4	5	6	7			
Contents	Empty	HPLC H2O	HPLC H2O						Silica Gel	
Final	1	88	89	8					330.4	
Initial	0	100	100	0					300	
Gain	1	~2	~1					6	30.4	36.4

Impinger Color Clear Labeled?
 Silica Gel Condition Good Sealed?

Check COC for Sample IDs of Media Blanks



CHEMOURS - FAYETTEVILLE, NC
INPUTS FOR HFPO DIMER ACID CALCULATIONS
BLOWER INTAKE

Test Data

Run number	7	8
Location	Blower Intake	Blower Intake
Date	3/1/19	3/1/19
Time period	0813-1008	1237-1433
Operator	JM	JM

Inputs For Calcs.

Delta H	3.0000	3.0000
Stack temp. (deg.F)	51.4	61.4
Meter temp. (deg.F)	61.0	70.2
Sample volume (act.)	105.079	106.831
Barometric press. (in.Hg)	30.09	30.09
Volume H ₂ O imp. (ml)	10.0	2.0
Weight change sil. gel (g)	22.5	34.0
% CO ₂	0.0	0.0
% O ₂	20.9	20.9
% N ₂	79.1	79.1
Sample time (min.)	115.0	115.0
Nozzle dia. (in.)	0.365	0.365
Meter box cal.	1.0100	1.0100
Traverse points	1	1

ISOKINETIC FIELD DATA SHEET

EPA Method 0010 - HFPO Dimer Acid

Page ___ of ___

Client: Chemours
 W.O.#: 15418.002.010.0001
 Project ID: Chemours
 Mode/Source ID: Blower Intake
 Samp. Loc. ID: Intake
 Run No. ID: 7
 Test Method ID: M0010
 Date ID: 25FEB2019
 Source/Location: Blower Intake
 Sample Date: 3/1/19
 Baro. Press (in Hg): 30.09
 Operator: Mills

Stack Conditions	
Assumed	Actual
0	✓
20.9	✓
55	

Meter Box ID: WC29
 Meter Box Y: 1.0100 ✓
 Meter Box Del H: 1.9363
 Probe ID / Length: 3
 Probe Material: Boro
 Pitot / Thermocouple ID:
 Pitot Coefficient: NA 0.84
 Nozzle ID:
 Nozzle Measurements:
 Avg Nozzle Dia (in):
 Area of Stack (ft²):
 Sample Time:
 Total Traverse Pts: ONE ✓

Sample Train (ft³):
 Leak Check @ (in Hg):
 Pitot leak check good: NA
 Pitot Inspection good: NA
 Method 3 System good: NA
Temp Check
 Meter Box Temp:
 Reference Temp:
 Pass/Fall (+/- 2°):
 Temp Change Response:

K Factor		
Initial	Mid-Point	Final
0.002		0.002
14		10
yes / no	yes / no	yes / no
yes / no	yes / no	yes / no
yes / no	yes / no	yes / no
Pre-Test Set		Post-Test Set
53		54
37		34
Pass / Fail		Pass / Fail
yes / no		yes / no

TRAVERSE POINT NO.	SAMPLE TIME (min)	CLOCK TIME (plant time)	VELOCITY PRESSURE Delta P (in H2O)	ORIFICE PRESSURE Delta H (in H2O)	DRY GAS METER READING (ft³)	STACK TEMP (°F)	DGM OUTLET TEMP (°F)	PROBE TEMP (°F)	FILTER BOX TEMP (°F)	IMPINGER EXIT TEMP (°F)	SAMPLE TRAIN VAC (in Hg)	XAD EXIT TEMP (°F)	COMMENTS
0		0813			827.813								
5			NA	3.0	832.4	51	55	122	113	47	8	47	
10				3.0	836.9	52	55	112	110	42	8	42	
15				3.0	841.5	51	56	112	115	44	8	44	
20				3.0	846.1	52	57	111	113	45	8	42	
25				3.0	850.6	51	58	114	113	46	8	42	
30				3.0	855.5	51	58	117	113	46	8	42	
35				3.0	859.8	51	59	120	114	46	8	43	
40				3.0	864.7	51	60	121	115	46	8	43	
45				3.0	869.0	51	61	122	114	47	8	43	
50				3.0	873.6	51	61	122	113	47	8	43	
55				3.0	878.3	50	61	120	114	47	8	43	Pin intake 0901
60				3.0	883.0	51	62	120	115	47	8	43	
1:05				3.0	887.2	51	62	120	116	47	8	42	
1:10				3.0	891.7	50	63	117	115	48	8	42	0920 Resump
1:15				3.0	896.2	51	63	115	113	47	8	42	after pin
1:20				3.0	900.7	51	63	115	114	47	8	42	11 Amber
1:25				3.0	905.4	52	64	116	115	48	8	43	
1:30				3.0	910.1	52	64	116	114	49	8	43	
1:35				3.0	914.5	52	64	116	115	49	8	43	
1:40				3.0	918.9	52	64	115	115	49	8	43	
1:45				3.0	923.5	53	64	116	115	50	8	44	
1:50				3.0	928.2	53	64	115	114	49	8	44	
1:55		1008		3.0	932.892	52	65	115	114	50	8	44	

Avg Delta P	Avg Delta H	Total Volume	Avg Ts	Avg Tm	Min/Max	Min/Max	Max	Max Vac	Min/Max
Avg Sqrt Delta P	Avg Sqrt Del H	Comments:							

EPA Method 0010 from EPA SW-846



AMM

ISOKINETIC FIELD DATA SHEET

EPA Method 0010 - HFPO Dimer Acid

Client: Chemours
 W.O.#: 15418.002.010.0001
 Project ID: Chemours
 Mode/Source ID: Blower Intake
 Samp. Loc. ID: Intake
 Run No. ID: 8
 Test Method ID: M0010
 Date ID: 25FEB2019
 Source/Location: Blower Intake
 Sample Date: 2/1/19
 Baro. Press (in Hg):
 Operator: Mills

Stack Conditions

Assumed	Actual
0	
20.9	
65	

Meter Box ID: WC 29
 Meter Box Y: 102/80
 Meter Box Del H: 1.9363
 Probe ID / Length: 3
 Probe Material: Boro
 Pitot / Thermocouple ID:
 Pitot Coefficient: NA
 Nozzle ID: 0.84
 Nozzle Measurements:
 Avg Nozzle Dia (in):
 Area of Stack (ft²):
 Sample Time: ONE
 Total Traverse Pts: ONE ✓

K Factor: _____

Initial	Mid-Point	Final
0.009		0.002
15		62.810
yes / no	yes / no	yes / no
yes / no	yes / no	yes / no
yes / no	yes / no	yes / no
Pre-Test Set		Post-Test Set
62		62
62		63
Pass / Fail	Pass / Fail	Pass / Fail
yes / no	yes / no	yes / no

Temp Check:

Meter Box Temp: _____
 Reference Temp: _____
 Pass/Fail (+/- 2°): _____
 Temp Change Response: _____

TRAVERSE POINT NO.	SAMPLE TIME (min)	CLOCK TIME (plant time)	VELOCITY PRESSURE Delta P (in H2O)	ORIFICE PRESSURE Delta H (in H2O)	DRY GAS METER READING (ft ³)	STACK TEMP (°F)	DGM OUTLET TEMP (°F)	PROBE TEMP (°F)	FILTER BOX TEMP (°F)	IMPINGER EXIT TEMP (°F)	SAMPLE TRAIN VAC (in Hg)	XAD EXIT TEMP (°F)	COMMENTS
0		12:37 ✓	NA	3.0	933.110	60	65	127	113	56	8.5	54	
5			NA	3.0	937.7	60	65	127	113	56	8	46	
10			NA	3.0	942.2	61	65	120	113	50	8	47	
15			NA	3.0	946.9	61	66	117	113	52	8	47	
20			NA	3.0	951.5	60	67	118	113	56	8	47	
25			NA	3.0	956.1	60	68	119	114	53	8	46	
30			NA	3.0	960.8	61	69	117	113	54	8	47	
35			NA	3.0	965.4	60	70	119	113	54	8	47	
40			NA	3.0	969.9	61	70	119	114	53	8	47	
45			NA	3.0	974.5	60	70	119	113	54	8	48	
50			NA	3.0	979.0	61	70	120	114	54	8	48	1325 begin
55			NA	3.0	983.9	60	71	120	114	54	8	48	first change
60			NA	3.0	988.3	62	71	120	115	56	8	49	
1:05			NA	3.0	993.0	62	71	119	114	57	8	50	
1:10			NA	3.0	997.7	61	72	119	114	59	8	52	1345
1:15			NA	3.0	1002.1	62	72	119	113	61	8	53	
1:20			NA	3.0	1006.9	62	73	119	114	63	8	54	
1:25			NA	3.0	1011.3	62	72	120	113	63	8	56	
1:30			NA	3.0	1016.0	63	73	122	113	63	8	56	
1:35			NA	3.0	1020.5	63	73	120	114	63	8	56	
1:40			NA	3.0	1025.1	63	73	120	114	64	8	56	
1:45			NA	3.0	1029.8	63	73	119	115	64	8	56	
1:50			NA	3.0	1034.6	62	73	119	113	64	8	57	
1:55			NA	3.0	1039.94	62	74	119	114	64	8	58	
		14:33 ✓	NA										
			Avg Delta P	Avg Delta H	Total Volume	Avg Ts	Avg Tm	Min/Max	Min/Max	Max	Max Vac	Min/Max	
			Avg Sqrt Delta P	Avg Sqrt Del H	Comments:								



EPA Method 0010 from EPA SW-846

amrd

SAMPLE RECOVERY FIELD DATA

EPA Method 0010 - HFPO Dimer Acid

Client Chemours W.O.# 15418.002.010.0001
 Location/Plant Fayetteville, NC Source & Location Blower Intake Intake

Run No. 7 Sample Date 3/11/19 Recovery Date 3/11/19
 Sample I.D. Chemours - Blower Intake - - 7 - M0010 - Analyst WMA Filter Number NA

	Impinger							Imp.Total	8	Total
	1	2	3	4	5	6	7			
Contents	Empty	HPLC H2O	HPLC H2O						Silica Gel	
Final	7	96	99	6					325	
Initial	0	100	100	0					300	
Gain	7	-4	-1	6				10	25	325

Impinger Color clear Labeled?
 Silica Gel Condition good Sealed?

Run No. 8 Sample Date 3/11/19 Recovery Date 3/11/19
 Sample I.D. Chemours - Blower Intake - - 8 - M0010 - Analyst WMA Filter Number NA

	Impinger							Imp.Total	8	Total
	1	2	3	4	5	6	7			
Contents	Empty	HPLC H2O	HPLC H2O						Silica Gel	
Final	0	92	96	2					334.0	
Initial	0	100	100	0					300	
Gain	0	-8	-4	2				10	34.0	334.0

Impinger Color clear Labeled?
 Silica Gel Condition Good Sealed?

Run No. Sample Date Recovery Date
 Sample I.D. Chemours - Blower Intake - - 0 - M0010 - Analyst Filter Number

	Impinger							Imp.Total	8	Total
	1	2	3	4	5	6	7			
Contents	Empty	HPLC H2O	HPLC H2O						Silica Gel	
Final										
Initial		100	100						300	
Gain										

Impinger Color Labeled?
 Silica Gel Condition Sealed?

Check COC for Sample IDs of Media Blanks



METHODS AND ANALYZERS

Client: **Chemours**
Location: **CHEMOURS**
Source: **VE North Carbon Bed/Division**

Project Number: **15418.002.010**
Operator: **SD**
Date: **25 Feb 2019**

Folders.A-F\Chemours Fayetteville\15418.002.010 VE North 2019\Data\FEBUARY_MARCH 2019\022519 DIVISION

Program Version: 2.1, built 19 May 2017 **File Version:** 2.03

Computer: WSWCAIRSERVICES **Trailer:** 27

Analog Input Device: Keithley KUSB-3108

Channel 1

Analyte	O₂
Method	EPA 3A, Using Bias
Analyzer Make, Model & Serial No.	Servomex 4900
Full-Scale Output, mv	10000
Analyzer Range, %	25.0
Span Concentration, %	21.0

Channel 2

Analyte	CO₂
Method	EPA 3A, Using Bias
Analyzer Make, Model & Serial No.	Servomex 4900
Full-Scale Output, mv	10000
Analyzer Range, %	20.0
Span Concentration, %	16.6

CALIBRATION DATA

Number 1

Client: **Chemours**
Location: **CHEMOURS**
Source: **VE North Carbon Bed/Division**

Project Number: **15418.002.010**
Operator: **SD**
Date: **25 Feb 2019**

Start Time: 10:59

O₂

Method: EPA 3A

Calibration Type: Linear Zero and High Span

Calibration Standards

%	Cylinder ID
12.0	CC18055
21.0	SG9169108

Calibration Results

Zero	6 mv
Span, 21.0 %	7997 mv

Curve Coefficients

Slope	Intercept
380.5	6

CO₂

Method: EPA 3A

Calibration Type: Linear Zero and High Span

Calibration Standards

%	Cylinder ID
8.9	CC18055
16.6	SG9169108

Calibration Results

Zero	4 mv
Span, 16.6 %	8287 mv

Curve Coefficients

Slope	Intercept
499.6	4

CALIBRATION ERROR DATA

Number 1

Client: **Chemours**
Location: **CHEMOURS**
Source: **VE North Carbon Bed/Division** Calibration 1

Project Number: **15418.002.010**
Operator: **SD**
Date: **25 Feb 2019**

Start Time: 10:59

O₂

Method: EPA 3A

Span Conc. 21.0 %

Slope 380.5 **Intercept 6.0**

Standard	Result	Difference	Error	Status
%	%	%	%	
Zero	0.0	0.0	0.0	Pass
12.0	12.0	0.0	0.0	Pass
21.0	21.0	0.0	0.0	Pass

CO₂

Method: EPA 3A

Span Conc. 16.6 %

Slope 499.6 **Intercept 4.0**

Standard	Result	Difference	Error	Status
%	%	%	%	
Zero	0.0	0.0	0.0	Pass
8.9	8.9	0.0	0.0	Pass
16.6	16.6	0.0	0.0	Pass

BIAS

Number 1

Client: **Chemours**
Location: **CHEMOURS**
Source: **VE North Carbon Bed/Division** Calibration 1

Project Number: **15418.002.010**
Operator: **SD**
Date: **25 Feb 2019**

Start Time: 11:05

O₂
Method: EPA 3A
Span Conc. 21.0 %

Bias Results					
Standard	Cal.	Bias	Difference	Error	Status
Gas	%	%	%	%	
Zero	0.0	0.0	0.0	0.0	Pass
Span	12.0	12.0	0.0	0.0	Pass

CO₂
Method: EPA 3A
Span Conc. 16.6 %

Bias Results					
Standard	Cal.	Bias	Difference	Error	Status
Gas	%	%	%	%	
Zero	0.0	0.0	0.0	0.0	Pass
Span	8.9	8.8	-0.1	-0.6	Pass

RUN DATA

Client: **Chemours**
Location: **CHEMOURS**
Source: **VE North Carbon Bed/Division** Calibration 1

Project Number: **15418.002.010**
Operator: **SD**
Date: **25 Feb 2019**

Time	O ₂ %	CO ₂ %
response times		
11:07:50	12.1	8.8
11:08:00	16.9	4.7
11:08:10	20.4	0.9
11:08:20	20.7	0.4
11:08:30	12.4	2.0
11:08:40	1.6	0.6
11:08:50	0.1	0.1
O2/CO2 UP		
11:09:00	0.0	0.0
11:09:10	0.0	0.0
11:09:20	0.0	0.0
11:09:30	3.0	1.8
11:09:40	10.4	7.1
11:09:50	11.8	8.6
11:10:00	12.0	8.8
O2/CO2 DOWN		
11:10:10	12.0	8.8
11:10:20	12.0	8.8
11:10:30	12.0	8.8
11:10:40	9.6	7.2
11:10:50	1.5	1.8
11:11:00	0.1	0.3
11:11:10	0.0	0.1
END		
11:11:20	0.0	0.1
11:11:30	0.0	0.1
Avg	7.3	3.5

RUN SUMMARY

Client: **Chemours**
Location: **CHEMOURS**
Source: **VE North Carbon Bed/Division** Calibration 1

Project Number: **15418.002.010**
Operator: **SD**
Date: **25 Feb 2019**

Method	O₂	CO₂
Conc. Units	EPA 3A	EPA 3A
	%	%

Time: 11:07:40 to 11:11:30

Run Averages

7.3 3.5

Pre-run Bias at 11:05

Zero Bias	0.0	0.0
Span Bias	12.0	8.8
Span Gas	12.0	8.9

Post-run Bias at 07:37

Zero Bias	0.0	0.1
Span Bias	12.0	8.9
Span Gas	12.0	8.9

Run averages corrected for the average of the pre-run and post-run bias

7.3 3.4

BIAS AND CALIBRATION DRIFT

Number 2

Client: **Chemours**
Location: **CHEMOURS**
Source: **VE North Carbon Bed/Division** Calibration 1

Project Number: **15418.002.010**
Operator: **SD**
Date: **26 Feb 2019**

Start Time: 07:37

O₂
Method: EPA 3A
Span Conc. 21.0 %

Bias Results					
Standard	Cal.	Bias	Difference	Error	Status
Gas	%	%	%	%	
Zero	0.0	0.0	0.0	0.0	Pass
Span	12.0	12.0	0.0	0.0	Pass

Calibration Drift					
Standard	Initial*	Final	Difference	Drift	Status
Gas	%	%	%	%	
Zero	0.0	0.0	0.0	0.0	Pass
Span	12.0	12.0	0.0	0.0	Pass

*Bias No. 1

CO₂
Method: EPA 3A
Span Conc. 16.6 %

Bias Results					
Standard	Cal.	Bias	Difference	Error	Status
Gas	%	%	%	%	
Zero	0.0	0.1	0.1	0.6	Pass
Span	8.9	8.9	0.0	0.0	Pass

Calibration Drift					
Standard	Initial*	Final	Difference	Drift	Status
Gas	%	%	%	%	
Zero	0.0	0.1	0.1	0.6	Pass
Span	8.8	8.9	0.1	0.6	Pass

*Bias No. 1

RUN DATA

Number 1

Client: **Chemours**
Location: **CHEMOURS**
Source: **VE North Carbon Bed/Division** Calibration 1

Project Number: **15418.002.010**
Operator: **SD**
Date: **26 Feb 2019**

Time	O ₂ %	CO ₂ %
RUN 1		
PORT 1		
09:27	20.9	0.1
09:28	20.9	0.1
09:29	20.9	0.1
09:30	20.9	0.1
09:31	20.9	0.1
09:32	20.9	0.1
09:33	20.9	0.2
09:34	20.9	0.2
09:35	20.9	0.2
09:36	20.9	0.2
09:37	20.9	0.2
09:38	20.9	0.2
09:39	20.9	0.2
09:40	20.9	0.2
09:41	20.9	0.2
09:42	20.9	0.2
09:43	20.9	0.2
09:44	20.9	0.2
09:45	20.9	0.2
09:46	20.9	0.2
09:47	20.9	0.2
09:48	20.9	0.2
09:49	20.9	0.2
09:50	20.9	0.2
09:51	20.9	0.2
09:52	20.9	0.2
09:53	20.9	0.2
09:54	20.9	0.2
09:55	20.9	0.2
09:56	20.9	0.2
09:57	20.9	0.2
09:58	20.9	0.2
09:59	20.9	0.2
10:00	20.9	0.2
10:01	20.9	0.2
10:02	20.9	0.2
10:03	20.9	0.2
10:04	20.9	0.2

RUN DATA

Number 1

Client: **Chemours**
Location: **CHEMOURS**
Source: **VE North Carbon Bed/Division** Calibration 1

Project Number: **15418.002.010**
Operator: **SD**
Date: **26 Feb 2019**

Time	O ₂ %	CO ₂ %
10:05	20.9	0.2
10:06	20.9	0.2
10:07	20.9	0.2
10:08	20.9	0.2
10:09	20.9	0.2
10:10	20.9	0.2
10:11	20.9	0.2
10:12	20.9	0.2
10:13	20.9	0.2
10:14	20.9	0.2
10:15	20.9	0.2
PORT CHANGE		
PORT 2		
10:55	20.9	0.1
10:56	20.9	0.1
10:57	20.8	0.1
10:58	20.8	0.2
10:59	20.8	0.2
11:00	20.9	0.2
11:01	20.9	0.3
11:02	20.9	0.3
11:03	20.9	0.3
11:04	20.9	0.2
11:05	20.9	0.2
11:06	20.9	0.2
11:07	20.9	0.2
11:08	20.9	0.2
11:09	20.9	0.2
11:10	20.9	0.2
11:11	20.9	0.2
11:12	20.9	0.2
11:13	20.9	0.2
11:14	20.9	0.2
11:15	20.9	0.2
11:16	20.9	0.2
11:17	20.9	0.2
11:18	20.9	0.2
11:19	20.9	0.2
11:20	20.9	0.2
11:21	20.9	0.2

RUN DATA

Number 1

Client: **Chemours**
Location: **CHEMOURS**
Source: **VE North Carbon Bed/Division** Calibration 1

Project Number: **15418.002.010**
Operator: **SD**
Date: **26 Feb 2019**

Time	O ₂ %	CO ₂ %
11:22	20.9	0.2
11:23	20.9	0.2
11:24	20.9	0.2
11:25	20.9	0.2
11:26	20.9	0.2
11:27	20.9	0.2
11:28	20.9	0.2
11:29	20.9	0.2
11:30	20.9	0.1
11:31	20.9	0.1
11:32	20.9	0.1
11:33	20.9	0.1
11:34	20.9	0.1
11:35	20.9	0.1
11:36	20.9	0.1
11:37	20.9	0.1
11:38	20.9	0.1
11:39	20.9	0.1
11:40	20.9	0.1
11:41	20.9	0.1
11:42	20.9	0.1
11:43	20.9	0.1
Avg	20.9	0.2

RUN SUMMARY

Number 1

Client: **Chemours**
Location: **CHEMOURS**
Source: **VE North Carbon Bed/Division** Calibration 1

Project Number: **15418.002.010**
Operator: **SD**
Date: **26 Feb 2019**

Method	O ₂	CO ₂
Conc. Units	EPA 3A	EPA 3A
	%	%

Time: 09:26 to 11:43

Run Averages

20.9 0.2

Pre-run Bias at 07:37

Zero Bias	0.0	0.1
Span Bias	12.0	8.9
Span Gas	12.0	8.9

Post-run Bias at 11:44

Zero Bias	0.0	0.1
Span Bias	12.0	8.9
Span Gas	12.0	8.9

Run averages corrected for the average of the pre-run and post-run bias

20.9 0.1

BIAS AND CALIBRATION DRIFT

Number 3

Client: **Chemours**
Location: **CHEMOURS**
Source: **VE North Carbon Bed/Division** Calibration 1

Project Number: **15418.002.010**
Operator: **SD**
Date: **26 Feb 2019**

Start Time: 11:44

O₂
Method: EPA 3A
Span Conc. 21.0 %

Bias Results					
Standard	Cal.	Bias	Difference	Error	Status
Gas	%	%	%	%	
Zero	0.0	0.0	0.0	0.0	Pass
Span	12.0	12.0	0.0	0.0	Pass

Calibration Drift					
Standard	Initial*	Final	Difference	Drift	Status
Gas	%	%	%	%	
Zero	0.0	0.0	0.0	0.0	Pass
Span	12.0	12.0	0.0	0.0	Pass

*Bias No. 2

CO₂
Method: EPA 3A
Span Conc. 16.6 %

Bias Results					
Standard	Cal.	Bias	Difference	Error	Status
Gas	%	%	%	%	
Zero	0.0	0.1	0.1	0.6	Pass
Span	8.9	8.9	0.0	0.0	Pass

Calibration Drift					
Standard	Initial*	Final	Difference	Drift	Status
Gas	%	%	%	%	
Zero	0.1	0.1	0.0	0.0	Pass
Span	8.9	8.9	0.0	0.0	Pass

*Bias No. 2

RUN DATA

Number 2

Client: **Chemours**
Location: **CHEMOURS**
Source: **VE North Carbon Bed/Division** Calibration 1

Project Number: **15418.002.010**
Operator: **SD**
Date: **26 Feb 2019**

Time	O ₂ %	CO ₂ %
R2 START		
13:35	20.8	0.1
13:36	20.7	0.5
13:37	20.7	0.6
13:38	20.8	0.4
13:39	20.8	0.3
13:40	20.8	0.3
13:41	20.8	0.2
13:42	20.8	0.2
13:43	20.8	0.2
13:44	20.8	0.2
13:45	20.8	0.2
13:46	20.8	0.2
13:47	20.9	0.2
13:48	20.9	0.2
13:49	20.9	0.1
13:50	20.9	0.2
13:51	20.9	0.2
13:52	20.8	0.2
13:53	20.8	0.2
13:54	20.8	0.2
13:55	20.8	0.2
13:56	20.8	0.2
13:57	20.8	0.1
13:58	20.8	0.1
13:59	20.8	0.1
14:00	20.8	0.1
14:01	20.8	0.1
14:02	20.8	0.1
14:03	20.8	0.1
14:04	20.8	0.1
14:05	20.8	0.1
14:06	20.8	0.1
14:07	20.8	0.1
14:08	20.8	0.1
14:09	20.9	0.1
14:10	20.8	0.1
14:11	20.8	0.1
14:12	20.8	0.1
14:13	20.8	0.1

RUN DATA

Number 2

Client: **Chemours**
Location: **CHEMOURS**
Source: **VE North Carbon Bed/Division** Calibration 1

Project Number: **15418.002.010**
Operator: **SD**
Date: **26 Feb 2019**

Time	O ₂ %	CO ₂ %
14:14	20.8	0.1
14:15	20.8	0.1
14:16	20.8	0.1
14:17	20.8	0.1
14:18	20.8	0.1
14:19	20.8	0.1
14:20	20.8	0.1
14:21	20.8	0.1
14:22	20.8	0.1
14:23	20.8	0.1
PORT CHANGE		
PORT 2		
14:42	20.8	0.1
14:43	20.8	0.1
14:44	20.8	0.1
14:45	20.8	0.1
14:46	20.8	0.1
14:47	20.8	0.1
14:48	20.8	0.1
14:49	20.8	0.1
14:50	20.8	0.1
14:51	20.8	0.1
14:52	20.8	0.1
14:53	20.8	0.1
14:54	20.8	0.1
14:55	20.8	0.1
14:56	20.8	0.1
14:57	20.8	0.1
14:58	20.8	0.1
14:59	20.8	0.1
15:00	20.8	0.1
15:01	20.8	0.1
15:02	20.8	0.1
15:03	20.8	0.1
15:04	20.8	0.1
15:05	20.8	0.1
15:06	20.8	0.1
15:07	20.8	0.1
15:08	20.8	0.1
15:09	20.8	0.1

RUN DATA

Number 2

Client: **Chemours**
Location: **CHEMOURS**
Source: **VE North Carbon Bed/Division** Calibration 1

Project Number: **15418.002.010**
Operator: **SD**
Date: **26 Feb 2019**

Time	O ₂ %	CO ₂ %
15:10	20.8	0.1
15:11	20.8	0.1
15:12	20.8	0.1
15:13	20.8	0.1
15:14	20.8	0.1
15:15	20.8	0.1
15:16	20.8	0.1
15:17	20.8	0.1
15:18	20.8	0.1
15:19	20.8	0.1
15:20	20.8	0.1
15:21	20.8	0.1
15:22	20.8	0.1
15:23	20.8	0.1
15:24	20.8	0.1
15:25	20.8	0.1
15:26	20.8	0.1
15:27	20.8	0.1
15:28	20.8	0.1
15:29	20.8	0.1
15:30	20.8	0.1
Avg	20.8	0.1

RUN SUMMARY

Number 2

Client: **Chemours**
Location: **CHEMOURS**
Source: **VE North Carbon Bed/Division** Calibration 1

Project Number: **15418.002.010**
Operator: **SD**
Date: **26 Feb 2019**

Method	O ₂	CO ₂
Conc. Units	EPA 3A	EPA 3A
	%	%

Time: 13:34 to 15:30

Run Averages

20.8 0.1

Pre-run Bias at 11:44

Zero Bias	0.0	0.1
Span Bias	12.0	8.9
Span Gas	12.0	8.9

Post-run Bias at 15:33

Zero Bias	0.0	0.1
Span Bias	11.9	9.0
Span Gas	12.0	8.9

Run averages corrected for the average of the pre-run and post-run bias

20.9 0.0

BIAS AND CALIBRATION DRIFT

Number 4

Client: **Chemours**
Location: **CHEMOURS**
Source: **VE North Carbon Bed/Division** Calibration 1

Project Number: **15418.002.010**
Operator: **SD**
Date: **26 Feb 2019**

Start Time: 15:33

O₂
Method: EPA 3A
Span Conc. 21.0 %

Bias Results					
Standard	Cal.	Bias	Difference	Error	Status
Gas	%	%	%	%	
Zero	0.0	0.0	0.0	0.0	Pass
Span	12.0	11.9	-0.1	-0.5	Pass

Calibration Drift					
Standard	Initial*	Final	Difference	Drift	Status
Gas	%	%	%	%	
Zero	0.0	0.0	0.0	0.0	Pass
Span	12.0	11.9	-0.1	-0.5	Pass

*Bias No. 3

CO₂
Method: EPA 3A
Span Conc. 16.6 %

Bias Results					
Standard	Cal.	Bias	Difference	Error	Status
Gas	%	%	%	%	
Zero	0.0	0.1	0.1	0.6	Pass
Span	8.9	9.0	0.1	0.6	Pass

Calibration Drift					
Standard	Initial*	Final	Difference	Drift	Status
Gas	%	%	%	%	
Zero	0.1	0.1	0.0	0.0	Pass
Span	8.9	9.0	0.1	0.6	Pass

*Bias No. 3

METHODS AND ANALYZERS

Client: **Chemours**
Location: **CHEMOURS**
Source: **VE North Carbon Bed/Division**

Project Number: **15418.002.010**
Operator: **SD**
Date: **27 Feb 2019**

Folders.A-F\Chemours Fayetteville\15418.002.010 VE North 2019\Data\FEBUARY_MARCH 2019\022719DIVISION

Program Version: 2.1, built 19 May 2017 **File Version:** 2.03

Computer: WSWCAIRSERVICES **Trailer:** 27

Analog Input Device: Keithley KUSB-3108

Channel 1

Analyte	O₂
Method	EPA 3A, Using Bias
Analyzer Make, Model & Serial No.	Servomex 4900
Full-Scale Output, mv	10000
Analyzer Range, %	25.0
Span Concentration, %	21.0

Channel 2

Analyte	CO₂
Method	EPA 3A, Using Bias
Analyzer Make, Model & Serial No.	Servomex 4900
Full-Scale Output, mv	10000
Analyzer Range, %	20.0
Span Concentration, %	16.6

CALIBRATION DATA

Number 1

Client: **Chemours**
Location: **CHEMOURS**
Source: **VE North Carbon Bed/Division**

Project Number: **15418.002.010**
Operator: **SD**
Date: **27 Feb 2019**

Start Time: 07:29

O₂

Method: EPA 3A

Calibration Type: Linear Zero and High Span

Calibration Standards

%	Cylinder ID
12.0	CC18055
21.0	SG9169108

Calibration Results

Zero	-3 mv
Span, 21.0 %	8006 mv

Curve Coefficients

Slope	Intercept
381.4	-3

CO₂

Method: EPA 3A

Calibration Type: Linear Zero and High Span

Calibration Standards

%	Cylinder ID
8.9	CC18055
16.6	SG9169108

Calibration Results

Zero	-5 mv
Span, 16.6 %	8288 mv

Curve Coefficients

Slope	Intercept
500.2	-5

CALIBRATION ERROR DATA

Number 1

Client: **Chemours**
Location: **CHEMOURS**
Source: **VE North Carbon Bed/Division** Calibration 1

Project Number: **15418.002.010**
Operator: **SD**
Date: **27 Feb 2019**

Start Time: 07:29

O₂

Method: EPA 3A

Span Conc. 21.0 %

Slope 381.4

Intercept -3.0

Standard	Result	Difference	Error	Status
%	%	%	%	
Zero	0.0	0.0	0.0	Pass
12.0	12.1	0.1	0.5	Pass
21.0	21.0	0.0	0.0	Pass

CO₂

Method: EPA 3A

Span Conc. 16.6 %

Slope 500.2

Intercept -5.0

Standard	Result	Difference	Error	Status
%	%	%	%	
Zero	0.0	0.0	0.0	Pass
8.9	8.6	-0.3	-1.8	Pass
16.6	16.6	0.0	0.0	Pass

BIAS
Number 1

Client: **Chemours**
Location: **CHEMOURS**
Source: **VE North Carbon Bed/Division** Calibration 1

Project Number: **15418.002.010**
Operator: **SD**
Date: **27 Feb 2019**

Start Time: 07:39

O₂
Method: EPA 3A
Span Conc. 21.0 %

Bias Results					
Standard	Cal.	Bias	Difference	Error	Status
Gas	%	%	%	%	
Zero	0.0	0.0	0.0	0.0	Pass
Span	12.1	12.0	-0.1	-0.5	Pass

CO₂
Method: EPA 3A
Span Conc. 16.6 %

Bias Results					
Standard	Cal.	Bias	Difference	Error	Status
Gas	%	%	%	%	
Zero	0.0	0.1	0.1	0.6	Pass
Span	8.6	8.4	-0.2	-1.2	Pass

RUN DATA

Number 1

Client: **Chemours**
Location: **CHEMOURS**
Source: **VE North Carbon Bed/Division** Calibration 1

Project Number: **15418.002.010**
Operator: **SD**
Date: **27 Feb 2019**

Time	O ₂ %	CO ₂ %
RUN 3		
POINT 1		
08:40	20.8	0.1
08:41	20.7	0.1
08:42	20.8	0.1
08:43	20.8	0.1
08:44	20.8	0.1
08:45	20.8	0.1
08:46	20.8	0.1
08:47	20.8	0.1
08:48	20.8	0.1
08:49	20.8	0.1
08:50	20.8	0.1
08:51	20.8	0.1
08:52	20.8	0.1
08:53	20.8	0.1
08:54	20.8	0.1
08:55	20.9	0.1
08:56	20.9	0.1
08:57	20.9	0.1
08:58	20.9	0.1
08:59	20.9	0.1
09:00	20.9	0.1
09:01	20.9	0.1
09:02	20.9	0.1
09:03	20.9	0.1
09:04	20.9	0.1
09:05	20.9	0.1
09:06	20.9	0.1
09:07	20.9	0.1
09:08	20.9	0.1
09:09	20.9	0.1
09:10	20.9	0.1
09:11	20.9	0.1
09:12	20.9	0.1
09:13	20.9	0.1
09:14	20.9	0.1
09:15	20.9	0.1
09:16	20.9	0.1
09:17	20.9	0.1

RUN DATA

Number 1

Client: **Chemours**
Location: **CHEMOURS**
Source: **VE North Carbon Bed/Division** Calibration 1

Project Number: **15418.002.010**
Operator: **SD**
Date: **27 Feb 2019**

Time	O ₂ %	CO ₂ %
09:18	20.9	0.1
09:19	20.9	0.1
09:20	20.9	0.1
09:21	20.9	0.1
09:22	20.9	0.1
09:23	20.9	0.1
09:24	20.9	0.1
09:25	20.9	0.1
09:26	20.9	0.1
09:27	20.9	0.1
09:28	20.9	0.1
PORT CHANGE		
PORT 2		
09:47	20.8	0.1
09:48	20.8	0.1
09:49	20.8	0.1
09:50	20.8	0.1
09:51	20.7	0.1
09:52	20.7	0.1
09:53	20.7	0.1
09:54	20.8	0.1
09:55	20.9	0.1
09:56	20.9	0.1
09:57	20.9	0.1
09:58	20.9	0.1
09:59	20.9	0.1
10:00	20.9	0.1
10:01	20.9	0.1
10:02	20.9	0.1
10:03	20.9	0.1
10:04	20.9	0.1
10:05	20.9	0.1
10:06	20.9	0.1
10:07	20.9	0.1
10:08	20.9	0.1
10:09	20.9	0.1
10:10	20.9	0.1
10:11	20.9	0.1
10:12	20.9	0.1
10:13	20.9	0.1

RUN DATA

Number 1

Client: **Chemours**
Location: **CHEMOURS**
Source: **VE North Carbon Bed/Division** Calibration 1

Project Number: **15418.002.010**
Operator: **SD**
Date: **27 Feb 2019**

Time	O ₂ %	CO ₂ %
10:14	20.9	0.1
10:15	20.9	0.1
10:16	20.9	0.1
10:17	20.9	0.1
10:18	20.9	0.1
10:19	20.9	0.1
10:20	20.9	0.1
10:21	20.9	0.1
10:22	20.9	0.1
10:23	20.9	0.1
10:24	20.9	0.1
10:25	20.9	0.1
10:26	20.9	0.1
10:27	20.9	0.1
10:28	20.9	0.1
10:29	20.9	0.1
10:30	20.9	0.1
10:31	20.9	0.1
10:32	20.9	0.1
10:33	20.9	0.1
10:34	20.9	0.1
10:35	20.9	0.1
Avg	20.9	0.1

RUN SUMMARY

Number 1

Client: **Chemours**
Location: **CHEMOURS**
Source: **VE North Carbon Bed/Division** Calibration 1

Project Number: **15418.002.010**
Operator: **SD**
Date: **27 Feb 2019**

Method	O ₂	CO ₂
Conc. Units	EPA 3A	EPA 3A
	%	%

Time: 08:39 to 10:35

Run Averages

20.9 0.1

Pre-run Bias at 07:39

Zero Bias	0.0	0.1
Span Bias	12.0	8.4
Span Gas	12.0	8.9

Post-run Bias at 10:36

Zero Bias	0.0	0.1
Span Bias	12.1	8.4
Span Gas	12.0	8.9

Run averages corrected for the average of the pre-run and post-run bias

20.8 0.0

BIAS AND CALIBRATION DRIFT

Number 2

Client: **Chemours**
Location: **CHEMOURS**
Source: **VE North Carbon Bed/Division** Calibration 1

Project Number: **15418.002.010**
Operator: **SD**
Date: **27 Feb 2019**

Start Time: 10:36

O₂
Method: EPA 3A
Span Conc. 21.0 %

Bias Results					
Standard	Cal.	Bias	Difference	Error	Status
Gas	%	%	%	%	
Zero	0.0	0.0	0.0	0.0	Pass
Span	12.1	12.1	0.0	0.0	Pass

Calibration Drift					
Standard	Initial*	Final	Difference	Drift	Status
Gas	%	%	%	%	
Zero	0.0	0.0	0.0	0.0	Pass
Span	12.0	12.1	0.1	0.5	Pass

*Bias No. 1

CO₂
Method: EPA 3A
Span Conc. 16.6 %

Bias Results					
Standard	Cal.	Bias	Difference	Error	Status
Gas	%	%	%	%	
Zero	0.0	0.1	0.1	0.6	Pass
Span	8.6	8.4	-0.2	-1.2	Pass

Calibration Drift					
Standard	Initial*	Final	Difference	Drift	Status
Gas	%	%	%	%	
Zero	0.1	0.1	0.0	0.0	Pass
Span	8.4	8.4	0.0	0.0	Pass

*Bias No. 1

RUN DATA

Number 2

Client: **Chemours**
Location: **CHEMOURS**
Source: **VE North Carbon Bed/Division** Calibration 1

Project Number: **15418.002.010**
Operator: **SD**
Date: **27 Feb 2019**

Time	O ₂ %	CO ₂ %
------	---------------------	----------------------

RUN 4
PORT 1 ONLY (SEE NEXT RUN FOR SECOND PORT)

12:31	20.7	0.1
12:32	20.7	0.1
12:33	20.7	0.1
12:34	20.7	0.1
12:35	20.7	0.1
12:36	20.7	0.1
12:37	20.7	0.1
12:38	20.7	0.1
12:39	20.7	0.1
12:40	20.7	0.1
12:41	20.7	0.1
12:42	20.7	0.1
12:43	20.7	0.1
12:44	20.7	0.1
12:45	20.7	0.1
12:46	20.7	0.1
12:47	20.7	0.1
12:48	20.7	0.1
12:49	20.7	0.1
12:50	20.7	0.1
12:51	20.7	0.1
12:52	20.7	0.1
12:53	20.7	0.1
12:54	20.7	0.1
12:55	20.7	0.1
12:56	20.8	0.1
12:57	20.8	0.1
12:58	20.8	0.1
12:59	20.8	0.1
13:00	20.8	0.1
13:01	20.8	0.1
13:02	20.8	0.1
13:03	20.8	0.1
13:04	20.8	0.1
13:05	20.8	0.1
13:06	20.8	0.1
13:07	20.8	0.1
13:08	20.8	0.1

RUN DATA

Number 2

Client: **Chemours**
Location: **CHEMOURS**
Source: **VE North Carbon Bed/Division** Calibration 1

Project Number: **15418.002.010**
Operator: **SD**
Date: **27 Feb 2019**

Time	O ₂ %	CO ₂ %
13:09	20.8	0.1
13:10	20.8	0.1
13:11	20.8	0.1
13:12	20.8	0.1
13:13	20.8	0.1
13:14	20.8	0.1
13:15	20.8	0.1
13:16	20.8	0.1
13:17	20.8	0.1
13:18	20.8	0.1
13:19	20.8	0.1
Avg	20.7	0.1

RUN SUMMARY

Number 2

Client: **Chemours**
Location: **CHEMOURS**
Source: **VE North Carbon Bed/Division** Calibration 1

Project Number: **15418.002.010**
Operator: **SD**
Date: **27 Feb 2019**

Method	O ₂	CO ₂
Conc. Units	EPA 3A	EPA 3A
	%	%

Time: 12:30 to 13:19

Run Averages

20.7 0.1

Pre-run Bias at 10:36

Zero Bias	0.0	0.1
Span Bias	12.1	8.4
Span Gas	12.0	8.9

Post-run Bias at 13:21

Zero Bias	0.1	0.0
Span Bias	12.0	8.4
Span Gas	12.0	8.9

Run averages corrected for the average of the pre-run and post-run bias

20.7 0.1

BIAS AND CALIBRATION DRIFT

Number 3

Client: **Chemours**
Location: **CHEMOURS**
Source: **VE North Carbon Bed/Division** Calibration 1

Project Number: **15418.002.010**
Operator: **SD**
Date: **27 Feb 2019**

Start Time: 13:21

O₂

Method: EPA 3A
Span Conc. 21.0 %

Bias Results					
Standard	Cal.	Bias	Difference	Error	Status
Gas	%	%	%	%	
Zero	0.0	0.1	0.1	0.5	Pass
Span	12.1	12.0	-0.1	-0.5	Pass

Calibration Drift					
Standard	Initial*	Final	Difference	Drift	Status
Gas	%	%	%	%	
Zero	0.0	0.1	0.1	0.5	Pass
Span	12.1	12.0	-0.1	-0.5	Pass

*Bias No. 2

CO₂

Method: EPA 3A
Span Conc. 16.6 %

Bias Results					
Standard	Cal.	Bias	Difference	Error	Status
Gas	%	%	%	%	
Zero	0.0	0.0	0.0	0.0	Pass
Span	8.6	8.4	-0.2	-1.2	Pass

Calibration Drift					
Standard	Initial*	Final	Difference	Drift	Status
Gas	%	%	%	%	
Zero	0.1	0.0	-0.1	-0.6	Pass
Span	8.4	8.4	0.0	0.0	Pass

*Bias No. 2

RUN DATA

Number 3

Client: **Chemours**
Location: **CHEMOURS**
Source: **VE North Carbon Bed/Division** Calibration 1

Project Number: **15418.002.010**
Operator: **SD**
Date: **27 Feb 2019**

Time	O ₂ %	CO ₂ %
RUN 4		
PORT 2		
13:38	20.7	0.1
13:39	20.7	0.1
13:40	20.7	0.1
13:41	20.7	0.2
13:42	20.6	0.2
13:43	20.6	0.2
13:44	20.7	0.2
13:45	20.7	0.2
13:46	20.8	0.2
13:47	20.8	0.2
13:48	20.8	0.2
13:49	20.8	0.2
13:50	20.8	0.2
13:51	20.8	0.2
13:52	20.8	0.2
13:53	20.8	0.2
13:54	20.8	0.2
13:55	20.8	0.2
13:56	20.8	0.2
13:57	20.8	0.2
13:58	20.8	0.2
13:59	20.8	0.2
14:00	20.8	0.2
14:01	20.8	0.2
14:02	20.8	0.2
14:03	20.8	0.1
14:04	20.8	0.1
14:05	20.8	0.1
14:06	20.8	0.1
14:07	20.8	0.1
14:08	20.8	0.1
14:09	20.8	0.1
14:10	20.8	0.1
14:11	20.8	0.1
14:12	20.8	0.1
14:13	20.8	0.1
14:14	20.8	0.1
14:15	20.8	0.1

RUN DATA

Number 3

Client: **Chemours**
Location: **CHEMOURS**
Source: **VE North Carbon Bed/Division** Calibration 1

Project Number: **15418.002.010**
Operator: **SD**
Date: **27 Feb 2019**

Time	O ₂ %	CO ₂ %
14:16	20.8	0.1
14:17	20.8	0.1
14:18	20.8	0.1
14:19	20.8	0.1
14:20	20.8	0.1
14:21	20.8	0.1
14:22	20.8	0.1
14:23	20.8	0.1
14:24	20.8	0.1
14:25	20.8	0.1
14:26	20.8	0.1
Avg	20.8	0.1

RUN SUMMARY

Number 3

Client: **Chemours**
Location: **CHEMOURS**
Source: **VE North Carbon Bed/Division** Calibration 1

Project Number: **15418.002.010**
Operator: **SD**
Date: **27 Feb 2019**

Method	O ₂	CO ₂
Conc. Units	EPA 3A	EPA 3A
	%	%

Time: 13:37 to 14:26

Run Averages

20.8 0.1

Pre-run Bias at 13:21

Zero Bias	0.1	0.0
Span Bias	12.0	8.4
Span Gas	12.0	8.9

Post-run Bias at 14:28

Zero Bias	0.1	0.0
Span Bias	12.0	8.4
Span Gas	12.0	8.9

Run averages corrected for the average of the pre-run and post-run bias

20.9 0.2

BIAS AND CALIBRATION DRIFT

Number 4

Client: **Chemours**
Location: **CHEMOURS**
Source: **VE North Carbon Bed/Division** Calibration 1

Project Number: **15418.002.010**
Operator: **SD**
Date: **27 Feb 2019**

Start Time: 14:28

O₂
Method: EPA 3A
Span Conc. 21.0 %

Bias Results					
Standard	Cal.	Bias	Difference	Error	Status
Gas	%	%	%	%	
Zero	0.0	0.1	0.1	0.5	Pass
Span	12.1	12.0	-0.1	-0.5	Pass

Calibration Drift					
Standard	Initial*	Final	Difference	Drift	Status
Gas	%	%	%	%	
Zero	0.1	0.1	0.0	0.0	Pass
Span	12.0	12.0	0.0	0.0	Pass

*Bias No. 3

CO₂
Method: EPA 3A
Span Conc. 16.6 %

Bias Results					
Standard	Cal.	Bias	Difference	Error	Status
Gas	%	%	%	%	
Zero	0.0	0.0	0.0	0.0	Pass
Span	8.6	8.4	-0.2	-1.2	Pass

Calibration Drift					
Standard	Initial*	Final	Difference	Drift	Status
Gas	%	%	%	%	
Zero	0.0	0.0	0.0	0.0	Pass
Span	8.4	8.4	0.0	0.0	Pass

*Bias No. 3

BIAS AND CALIBRATION DRIFT

Number 5

Client: **Chemours**
Location: **CHEMOURS**
Source: **VE North Carbon Bed/Division** Calibration 1

Project Number: **15418.002.010**
Operator: **SD**
Date: **28 Feb 2019**

Start Time: 07:19

O₂
Method: EPA 3A
Span Conc. 21.0 %

Bias Results					
Standard	Cal.	Bias	Difference	Error	Status
Gas	%	%	%	%	
Zero	0.0	0.0	0.0	0.0	Pass
Span	12.1	11.8	-0.3	-1.4	Pass

Calibration Drift					
Standard	Initial*	Final	Difference	Drift	Status
Gas	%	%	%	%	
Zero	0.1	0.0	-0.1	-0.5	Pass
Span	12.0	11.8	-0.2	-1.0	Pass

*Bias No. 4

CO₂
Method: EPA 3A
Span Conc. 16.6 %

Bias Results					
Standard	Cal.	Bias	Difference	Error	Status
Gas	%	%	%	%	
Zero	0.0	0.1	0.1	0.6	Pass
Span	8.6	8.3	-0.3	-1.8	Pass

Calibration Drift					
Standard	Initial*	Final	Difference	Drift	Status
Gas	%	%	%	%	
Zero	0.0	0.1	0.1	0.6	Pass
Span	8.4	8.3	-0.1	-0.6	Pass

*Bias No. 4

RUN DATA

Number 4

Client: **Chemours**
Location: **CHEMOURS**
Source: **VE North Carbon Bed/Division** Calibration 1

Project Number: **15418.002.010**
Operator: **SD**
Date: **28 Feb 2019**

Time	O ₂ %	CO ₂ %
08:14	20.6	0.1
08:15	20.6	0.1
08:16	20.6	0.1
08:17	20.6	0.1
08:18	20.6	0.1
08:19	20.6	0.1
08:20	20.6	0.1
08:21	20.6	0.1
08:22	20.6	0.1
	RUN 5	
	PORT 1	
08:23	20.6	0.1
08:24	20.6	0.1
08:25	20.6	0.1
08:26	20.6	0.1
08:27	20.6	0.1
08:28	20.6	0.1
08:29	20.6	0.1
08:30	20.6	0.1
08:31	20.6	0.1
08:32	20.6	0.1
08:33	20.6	0.1
08:34	20.6	0.1
08:35	20.6	0.1
08:36	20.6	0.1
08:37	20.6	0.1
08:38	20.6	0.1
08:39	20.6	0.1
08:40	20.6	0.1
08:41	20.6	0.1
08:42	20.6	0.1
08:43	20.6	0.1
08:44	20.6	0.1
08:45	20.6	0.1
08:46	20.6	0.1
08:47	20.6	0.1
08:48	20.6	0.1
08:49	20.6	0.1
08:50	20.6	0.1
08:51	20.6	0.1

RUN DATA

Number 4

Client: **Chemours**
Location: **CHEMOURS**
Source: **VE North Carbon Bed/Division** Calibration 1

Project Number: **15418.002.010**
Operator: **SD**
Date: **28 Feb 2019**

Time	O ₂ %	CO ₂ %
08:52	20.6	0.1
08:53	20.6	0.1
08:54	20.6	0.1
08:55	20.6	0.1
08:56	20.6	0.1
08:57	20.6	0.1
08:58	20.6	0.1
08:59	20.6	0.1
09:00	20.6	0.1
09:01	20.6	0.1
09:02	20.6	0.1
09:03	20.6	0.1
09:04	20.6	0.1
09:05	20.6	0.1
09:06	20.6	0.1
09:07	20.7	0.1
09:08	20.7	0.1
09:09	20.7	0.1
09:10	20.7	0.1
09:11	20.7	0.1
PORT CHANGE		
09:12	20.7	0.1
09:13	20.7	0.1
09:14	20.7	0.1
09:15	20.7	0.1
09:16	20.6	0.1
09:17	20.6	0.1
09:18	20.6	0.1
09:19	20.6	0.1
09:20	20.6	0.1
09:21	20.6	0.1
09:22	20.6	0.1
09:23	20.6	0.1
09:24	20.6	0.1
09:25	20.6	0.1
09:26	20.6	0.1
09:27	20.6	0.1
09:28	20.6	0.1
09:29	20.6	0.1

RUN DATA

Number 4

Client: **Chemours**
Location: **CHEMOURS**
Source: **VE North Carbon Bed/Division** Calibration 1

Project Number: **15418.002.010**
Operator: **SD**
Date: **28 Feb 2019**

Time	O ₂ %	CO ₂ %
PORT 2		
09:30	20.6	0.1
09:31	20.6	0.1
09:32	20.6	0.1
09:33	20.6	0.1
09:34	20.6	0.2
09:35	20.6	0.2
09:36	20.6	0.2
09:37	20.6	0.2
09:38	20.6	0.2
09:39	20.6	0.2
09:40	20.6	0.2
09:41	20.7	0.2
09:42	20.7	0.2
09:43	20.7	0.2
09:44	20.7	0.2
09:45	20.7	0.2
09:46	20.7	0.2
09:47	20.7	0.2
09:48	20.7	0.2
09:49	20.7	0.2
09:50	20.7	0.2
09:51	20.7	0.2
09:52	20.7	0.2
09:53	20.7	0.2
09:54	20.7	0.2
09:55	20.7	0.2
09:56	20.7	0.1
09:57	20.8	0.1
09:58	20.8	0.1
09:59	20.8	0.1
10:00	20.8	0.1
10:01	20.8	0.1
10:02	20.8	0.1
10:03	20.8	0.1
10:04	20.8	0.1
10:05	20.8	0.1
10:06	20.8	0.1
10:07	20.8	0.1
10:08	20.8	0.1

RUN DATA

Number 4

Client: **Chemours**
Location: **CHEMOURS**
Source: **VE North Carbon Bed/Division** Calibration 1

Project Number: **15418.002.010**
Operator: **SD**
Date: **28 Feb 2019**

Time	O ₂ %	CO ₂ %
10:09	20.8	0.1
10:10	20.8	0.1
10:11	20.8	0.1
10:12	20.8	0.1
10:13	20.8	0.1
10:14	20.8	0.1
10:15	20.8	0.1
10:16	20.8	0.1
10:17	20.8	0.1
10:18	20.8	0.1
Avg	20.7	0.1

RUN SUMMARY

Number 4

Client: **Chemours**
Location: **CHEMOURS**
Source: **VE North Carbon Bed/Division** Calibration 1

Project Number: **15418.002.010**
Operator: **SD**
Date: **28 Feb 2019**

Method	O ₂	CO ₂
Conc. Units	EPA 3A	EPA 3A
	%	%

Time: 08:13 to 10:18

Run Averages

20.7 0.1

Pre-run Bias at 07:19

Zero Bias	0.0	0.1
Span Bias	11.8	8.3
Span Gas	12.0	8.9

Post-run Bias at 10:21

Zero Bias	0.0	0.0
Span Bias	12.0	8.3
Span Gas	12.0	8.9

Run averages corrected for the average of the pre-run and post-run bias

20.8 0.1

BIAS AND CALIBRATION DRIFT

Number 6

Client: **Chemours**
Location: **CHEMOURS**
Source: **VE North Carbon Bed/Division** Calibration 1

Project Number: **15418.002.010**
Operator: **SD**
Date: **28 Feb 2019**

Start Time: 10:21

O₂
Method: EPA 3A
Span Conc. 21.0 %

Bias Results					
Standard	Cal.	Bias	Difference	Error	Status
Gas	%	%	%	%	
Zero	0.0	0.0	0.0	0.0	Pass
Span	12.1	12.0	-0.1	-0.5	Pass

Calibration Drift					
Standard	Initial*	Final	Difference	Drift	Status
Gas	%	%	%	%	
Zero	0.0	0.0	0.0	0.0	Pass
Span	11.8	12.0	0.2	1.0	Pass

*Bias No. 5

CO₂
Method: EPA 3A
Span Conc. 16.6 %

Bias Results					
Standard	Cal.	Bias	Difference	Error	Status
Gas	%	%	%	%	
Zero	0.0	0.0	0.0	0.0	Pass
Span	8.6	8.3	-0.3	-1.8	Pass

Calibration Drift					
Standard	Initial*	Final	Difference	Drift	Status
Gas	%	%	%	%	
Zero	0.1	0.0	-0.1	-0.6	Pass
Span	8.3	8.3	0.0	0.0	Pass

*Bias No. 5

RUN DATA

Number 5

Client: **Chemours**
Location: **CHEMOURS**
Source: **VE North Carbon Bed/Division** Calibration 1

Project Number: **15418.002.010**
Operator: **SD**
Date: **28 Feb 2019**

Time	O ₂ %	CO ₂ %
14:12	20.6	0.1
14:13	20.6	0.1
14:14	20.6	0.1
14:15	20.6	0.1
14:16	20.6	0.1
14:17	20.6	0.1
14:18	20.6	0.1
14:19	20.6	0.1
14:20	20.6	0.1
14:21	20.6	0.1
14:22	20.6	0.1
14:23	20.6	0.1
14:24	20.6	0.1
14:25	20.6	0.1
14:26	20.6	0.1
14:27	20.6	0.1
14:28	20.6	0.1
	RUN 6	
	PORT 1	
14:29	20.6	0.1
14:30	20.5	0.2
14:31	20.5	0.4
14:32	20.5	0.2
14:33	20.6	0.2
14:34	20.6	0.1
14:35	20.6	0.1
14:36	20.6	0.1
14:37	20.6	0.1
14:38	20.6	0.1
14:39	20.6	0.1
14:40	20.6	0.1
14:41	20.6	0.1
14:42	20.6	0.1
14:43	20.6	0.1
14:44	20.6	0.1
14:45	20.6	0.1
14:46	20.6	0.1
14:47	20.6	0.1
14:48	20.6	0.1
14:49	20.6	0.1

RUN DATA

Number 5

Client: **Chemours**
Location: **CHEMOURS**
Source: **VE North Carbon Bed/Division** Calibration 1

Project Number: **15418.002.010**
Operator: **SD**
Date: **28 Feb 2019**

Time	O ₂ %	CO ₂ %
14:50	20.6	0.1
14:51	20.6	0.1
14:52	20.6	0.1
14:53	20.6	0.1
14:54	20.6	0.1
14:55	20.6	0.1
14:56	20.6	0.1
14:57	20.6	0.1
14:58	20.6	0.1
14:59	20.6	0.1
15:00	20.6	0.1
15:01	20.6	0.1
15:02	20.6	0.1
15:03	20.6	0.1
15:04	20.6	0.1
15:05	20.6	0.1
15:06	20.6	0.1
15:07	20.6	0.1
15:08	20.6	0.1
15:09	20.6	0.1
15:10	20.6	0.1
15:11	20.6	0.1
15:12	20.6	0.1
15:13	20.7	0.1
15:14	20.7	0.1
15:15	20.7	0.1
15:16	20.7	0.1
15:17	20.7	0.1
PORT CHANGE		
15:18	20.7	0.1
15:19	20.6	0.1
15:20	20.6	0.1
15:21	20.6	0.1
15:22	20.6	0.1
15:23	20.6	0.1
15:24	20.6	0.1
15:25	20.6	0.1
15:26	20.6	0.1
15:27	20.6	0.1
15:28	20.6	0.1

RUN DATA

Number 5

Client: **Chemours**
Location: **CHEMOURS**
Source: **VE North Carbon Bed/Division** Calibration 1

Project Number: **15418.002.010**
Operator: **SD**
Date: **28 Feb 2019**

Time	O ₂ %	CO ₂ %
15:29	20.6	0.1
15:30	20.6	0.1
15:31	20.6	0.1
15:32	20.6	0.1
15:33	20.6	0.1
15:34	20.6	0.1
15:35	20.6	0.1
15:36	20.6	0.1
15:37	20.6	0.1
15:38	20.6	0.1
	PORT 2	
15:39	20.6	0.1
15:40	20.6	0.1
15:41	20.6	0.1
15:42	20.6	0.1
15:43	20.6	0.1
15:44	20.6	0.1
15:45	20.6	0.1
15:46	20.6	0.1
15:47	20.6	0.1
15:48	20.7	0.1
15:49	20.7	0.1
15:50	20.7	0.1
15:51	20.7	0.1
15:52	20.7	0.1
15:53	20.7	0.1
15:54	20.7	0.1
15:55	20.7	0.1
15:56	20.7	0.1
15:57	20.7	0.1
15:58	20.7	0.1
15:59	20.7	0.1
16:00	20.7	0.1
16:01	20.7	0.1
16:02	20.7	0.1
16:03	20.7	0.1
16:04	20.7	0.1
16:05	20.7	0.1
16:06	20.7	0.1
16:07	20.7	0.1

RUN DATA

Number 5

Client: **Chemours**
Location: **CHEMOURS**
Source: **VE North Carbon Bed/Division** Calibration 1

Project Number: **15418.002.010**
Operator: **SD**
Date: **28 Feb 2019**

Time	O ₂ %	CO ₂ %
16:08	20.7	0.1
16:09	20.7	0.1
16:10	20.7	0.1
16:11	20.7	0.1
16:12	20.7	0.1
16:13	20.7	0.1
16:14	20.7	0.1
16:15	20.7	0.1
16:16	20.7	0.1
16:17	20.7	0.1
16:18	20.7	0.1
16:19	20.7	0.1
16:20	20.7	0.1
16:21	20.7	0.1
16:22	20.7	0.1
16:23	20.7	0.1
16:24	20.7	0.1
16:25	20.7	0.1
16:26	20.7	0.1
16:27	20.7	0.1
Avg	20.6	0.1

RUN SUMMARY

Number 5

Client: **Chemours**
Location: **CHEMOURS**
Source: **VE North Carbon Bed/Division** Calibration 1

Project Number: **15418.002.010**
Operator: **SD**
Date: **28 Feb 2019**

Method	O ₂	CO ₂
Conc. Units	EPA 3A	EPA 3A
	%	%

Time: 14:11 to 16:27

Run Averages

20.6 0.1

Pre-run Bias at 10:21

Zero Bias	0.0	0.0
Span Bias	12.0	8.3
Span Gas	12.0	8.9

Post-run Bias at 16:31

Zero Bias	0.0	0.0
Span Bias	11.9	8.4
Span Gas	12.0	8.9

Run averages corrected for the average of the pre-run and post-run bias

20.7 0.1

BIAS AND CALIBRATION DRIFT

Number 7

Client: **Chemours**
Location: **CHEMOURS**
Source: **VE North Carbon Bed/Division** Calibration 1

Project Number: **15418.002.010**
Operator: **SD**
Date: **28 Feb 2019**

Start Time: 16:31

O₂
Method: EPA 3A
Span Conc. 21.0 %

Bias Results					
Standard	Cal.	Bias	Difference	Error	Status
Gas	%	%	%	%	
Zero	0.0	0.0	0.0	0.0	Pass
Span	12.1	11.9	-0.2	-1.0	Pass

Calibration Drift					
Standard	Initial*	Final	Difference	Drift	Status
Gas	%	%	%	%	
Zero	0.0	0.0	0.0	0.0	Pass
Span	12.0	11.9	-0.1	-0.5	Pass

*Bias No. 6

CO₂
Method: EPA 3A
Span Conc. 16.6 %

Bias Results					
Standard	Cal.	Bias	Difference	Error	Status
Gas	%	%	%	%	
Zero	0.0	0.0	0.0	0.0	Pass
Span	8.6	8.4	-0.2	-1.2	Pass

Calibration Drift					
Standard	Initial*	Final	Difference	Drift	Status
Gas	%	%	%	%	
Zero	0.0	0.0	0.0	0.0	Pass
Span	8.3	8.4	0.1	0.6	Pass

*Bias No. 6

BIAS AND CALIBRATION DRIFT

Number 8

Client: **Chemours**
Location: **CHEMOURS**
Source: **VE North Carbon Bed/Division** Calibration 1

Project Number: **15418.002.010**
Operator: **SD**
Date: **1 Mar 2019**

Start Time: 07:24

O₂
Method: EPA 3A
Span Conc. 21.0 %

Bias Results					
Standard	Cal.	Bias	Difference	Error	Status
Gas	%	%	%	%	
Zero	0.0	0.0	0.0	0.0	Pass
Span	12.1	12.2	0.1	0.5	Pass

Calibration Drift					
Standard	Initial*	Final	Difference	Drift	Status
Gas	%	%	%	%	
Zero	0.0	0.0	0.0	0.0	Pass
Span	11.9	12.2	0.3	1.4	Pass

*Bias No. 7

CO₂
Method: EPA 3A
Span Conc. 16.6 %

Bias Results					
Standard	Cal.	Bias	Difference	Error	Status
Gas	%	%	%	%	
Zero	0.0	0.0	0.0	0.0	Pass
Span	8.6	8.3	-0.3	-1.8	Pass

Calibration Drift					
Standard	Initial*	Final	Difference	Drift	Status
Gas	%	%	%	%	
Zero	0.0	0.0	0.0	0.0	Pass
Span	8.4	8.3	-0.1	-0.6	Pass

*Bias No. 7

RUN DATA

Number 6

Client: **Chemours**
Location: **CHEMOURS**
Source: **VE North Carbon Bed/Division** Calibration 1

Project Number: **15418.002.010**
Operator: **SD**
Date: **1 Mar 2019**

Time	O ₂ %	CO ₂ %
RUN 7		
PORT 1		
08:13	21.2	0.1
08:14	21.0	0.7
08:15	21.1	0.5
08:16	21.1	0.3
08:17	21.1	0.2
08:18	21.1	0.2
08:19	21.2	0.1
08:20	21.1	0.1
08:21	21.2	0.1
08:22	21.2	0.1
08:23	21.2	0.1
08:24	21.2	0.1
08:25	21.2	0.1
08:26	21.2	0.1
08:27	21.2	0.1
08:28	21.2	0.1
08:29	21.2	0.1
08:30	21.2	0.1
08:31	21.2	0.1
08:32	21.2	0.1
08:33	21.2	0.1
08:34	21.2	0.1
08:35	21.2	0.1
08:36	21.2	0.1
08:37	21.2	0.1
08:38	21.2	0.1
08:39	21.2	0.1
08:40	21.2	0.1
08:41	21.2	0.1
08:42	21.2	0.1
08:43	21.2	0.1
08:44	21.2	0.1
08:45	21.2	0.1
08:46	21.2	0.1
08:47	21.2	0.1
08:48	21.2	0.1
08:49	21.2	0.1
08:50	21.2	0.1

RUN DATA

Number 6

Client: **Chemours**
Location: **CHEMOURS**
Source: **VE North Carbon Bed/Division** Calibration 1

Project Number: **15418.002.010**
Operator: **SD**
Date: **1 Mar 2019**

Time	O ₂ %	CO ₂ %
08:51	21.2	0.1
08:52	21.2	0.1
08:53	21.2	0.1
08:54	21.2	0.1
08:55	21.2	0.1
08:56	21.2	0.1
08:57	21.2	0.1
08:58	21.2	0.1
08:59	21.2	0.1
09:00	21.2	0.1
09:01	21.3	0.1
PORT CHANGE		
PORT 2		
09:20	21.2	0.1
09:21	21.2	0.1
09:22	21.2	0.1
09:23	21.2	0.2
09:24	21.2	0.2
09:25	21.2	0.2
09:26	21.2	0.2
09:27	21.2	0.2
09:28	21.2	0.2
09:29	21.2	0.2
09:30	21.2	0.2
09:31	21.3	0.2
09:32	21.3	0.2
09:33	21.3	0.2
09:34	21.3	0.2
09:35	21.3	0.2
09:36	21.3	0.2
09:37	21.3	0.2
09:38	21.3	0.2
09:39	21.3	0.2
09:40	21.3	0.2
09:41	21.3	0.2
09:42	21.3	0.1
09:43	21.3	0.1
09:44	21.3	0.1
09:45	21.3	0.1
09:46	21.3	0.1

RUN DATA

Number 6

Client: **Chemours**
Location: **CHEMOURS**
Source: **VE North Carbon Bed/Division** Calibration 1

Project Number: **15418.002.010**
Operator: **SD**
Date: **1 Mar 2019**

Time	O ₂ %	CO ₂ %
09:47	21.3	0.1
09:48	21.3	0.1
09:49	21.3	0.1
09:50	21.3	0.1
09:51	21.3	0.1
09:52	21.3	0.1
09:53	21.3	0.1
09:54	21.3	0.1
09:55	21.3	0.1
09:56	21.3	0.1
09:57	21.3	0.1
09:58	21.3	0.1
09:59	21.3	0.1
10:00	21.3	0.1
10:01	21.3	0.1
10:02	21.3	0.1
10:03	21.3	0.1
10:04	21.3	0.1
10:05	21.3	0.1
10:06	21.3	0.1
10:07	21.3	0.1
10:08	21.3	0.1
Avg	21.2	0.1

RUN SUMMARY

Number 6

Client: **Chemours**
Location: **CHEMOURS**
Source: **VE North Carbon Bed/Division** Calibration 1

Project Number: **15418.002.010**
Operator: **SD**
Date: **1 Mar 2019**

Method	O ₂	CO ₂
Conc. Units	EPA 3A	EPA 3A
	%	%

Time: 08:12 to 10:08

Run Averages

21.2 0.1

Pre-run Bias at 07:24

Zero Bias	0.0	0.0
Span Bias	12.2	8.3
Span Gas	12.0	8.9

Post-run Bias at 10:12

Zero Bias	0.0	0.0
Span Bias	12.2	8.4
Span Gas	12.0	8.9

Run averages corrected for the average of the pre-run and post-run bias

20.9 0.1

BIAS AND CALIBRATION DRIFT

Number 9

Client: **Chemours**
Location: **CHEMOURS**
Source: **VE North Carbon Bed/Division** Calibration 1

Project Number: **15418.002.010**
Operator: **SD**
Date: **1 Mar 2019**

Start Time: 10:12

O₂

Method: EPA 3A
Span Conc. 21.0 %

Bias Results					
Standard	Cal.	Bias	Difference	Error	Status
Gas	%	%	%	%	
Zero	0.0	0.0	0.0	0.0	Pass
Span	12.1	12.2	0.1	0.5	Pass

Calibration Drift					
Standard	Initial*	Final	Difference	Drift	Status
Gas	%	%	%	%	
Zero	0.0	0.0	0.0	0.0	Pass
Span	12.2	12.2	0.0	0.0	Pass

*Bias No. 8

CO₂

Method: EPA 3A
Span Conc. 16.6 %

Bias Results					
Standard	Cal.	Bias	Difference	Error	Status
Gas	%	%	%	%	
Zero	0.0	0.0	0.0	0.0	Pass
Span	8.6	8.4	-0.2	-1.2	Pass

Calibration Drift					
Standard	Initial*	Final	Difference	Drift	Status
Gas	%	%	%	%	
Zero	0.0	0.0	0.0	0.0	Pass
Span	8.3	8.4	0.1	0.6	Pass

*Bias No. 8

RUN DATA

Number 7

Client: **Chemours**
Location: **CHEMOURS**
Source: **VE North Carbon Bed/Division** Calibration 1

Project Number: **15418.002.010**
Operator: **SD**
Date: **1 Mar 2019**

Time	O ₂ %	CO ₂ %
RUN 8		
PORT 1		
12:37	21.1	0.1
12:38	21.1	0.1
12:39	21.1	0.1
12:40	21.1	0.1
12:41	21.1	0.1
12:42	21.1	0.1
12:43	21.1	0.1
12:44	21.1	0.1
12:45	21.1	0.1
12:46	21.1	0.1
12:47	21.1	0.1
12:48	21.1	0.1
12:49	21.1	0.1
12:50	21.1	0.1
12:51	21.1	0.1
12:52	21.1	0.1
12:53	21.1	0.1
12:54	21.1	0.1
12:55	21.1	0.1
12:56	21.1	0.1
12:57	21.1	0.1
12:58	21.1	0.1
12:59	21.1	0.1
13:00	21.1	0.1
13:01	21.1	0.1
13:02	21.1	0.1
13:03	21.1	0.1
13:04	21.1	0.1
13:05	21.1	0.1
13:06	21.1	0.1
13:07	21.1	0.1
13:08	21.1	0.1
13:09	21.1	0.1
13:10	21.2	0.1
13:11	21.2	0.1
13:12	21.2	0.1
13:13	21.2	0.1
13:14	21.2	0.1

RUN DATA

Number 7

Client: **Chemours**
Location: **CHEMOURS**
Source: **VE North Carbon Bed/Division** Calibration 1

Project Number: **15418.002.010**
Operator: **SD**
Date: **1 Mar 2019**

Time	O ₂ %	CO ₂ %
13:15	21.2	0.1
13:16	21.2	0.1
13:17	21.2	0.1
13:18	21.2	0.1
13:19	21.2	0.1
13:20	21.2	0.1
13:21	21.2	0.1
13:22	21.2	0.1
13:23	21.2	0.1
13:24	21.3	0.1
PORT CHANGE		
PORT 2		
13:45	21.1	0.1
13:46	21.1	0.1
13:47	21.1	0.1
13:48	21.1	0.1
13:49	21.1	0.1
13:50	21.1	0.1
13:51	21.1	0.1
13:52	21.1	0.1
13:53	21.1	0.1
13:54	21.1	0.1
13:55	21.1	0.1
13:56	21.2	0.1
13:57	21.2	0.1
13:58	21.2	0.1
13:59	21.2	0.1
14:00	21.2	0.1
14:01	21.2	0.1
14:02	21.2	0.1
14:03	21.2	0.1
14:04	21.2	0.1
14:05	21.2	0.1
14:06	21.3	0.1
14:07	21.2	0.1
14:08	21.2	0.1
14:09	21.2	0.1
14:10	21.2	0.1
14:11	21.2	0.1
14:12	21.2	0.1

RUN DATA

Number 7

Client: **Chemours**
Location: **CHEMOURS**
Source: **VE North Carbon Bed/Division** Calibration 1

Project Number: **15418.002.010**
Operator: **SD**
Date: **1 Mar 2019**

Time	O ₂ %	CO ₂ %
14:13	21.2	0.1
14:14	21.2	0.1
14:15	21.2	0.1
14:16	21.2	0.1
14:17	21.2	0.1
14:18	21.2	0.1
14:19	21.3	0.1
14:20	21.3	0.1
14:21	21.3	0.1
14:22	21.3	0.1
14:23	21.3	0.1
14:24	21.3	0.1
14:25	21.2	0.1
14:26	21.2	0.1
14:27	21.2	0.1
14:28	21.2	0.1
14:29	21.2	0.1
14:30	21.2	0.1
14:31	21.2	0.1
14:32	21.2	0.1
14:33	21.2	0.1
Avg	21.2	0.1

RUN SUMMARY

Number 7

Client: **Chemours**
Location: **CHEMOURS**
Source: **VE North Carbon Bed/Division** Calibration 1

Project Number: **15418.002.010**
Operator: **SD**
Date: **1 Mar 2019**

Method	O ₂	CO ₂
Conc. Units	EPA 3A	EPA 3A
	%	%

Time: 12:36 to 14:33

Run Averages

21.2 0.1

Pre-run Bias at 10:12

Zero Bias	0.0	0.0
Span Bias	12.2	8.4
Span Gas	12.0	8.9

Post-run Bias at 14:35

Zero Bias	0.0	0.0
Span Bias	12.1	8.3
Span Gas	12.0	8.9

Run averages corrected for the average of the pre-run and post-run bias

20.9 0.1

BIAS AND CALIBRATION DRIFT

Number 10

Client: **Chemours**
Location: **CHEMOURS**
Source: **VE North Carbon Bed/Division** Calibration 1

Project Number: **15418.002.010**
Operator: **SD**
Date: **1 Mar 2019**

Start Time: 14:35

O₂
Method: EPA 3A
Span Conc. 21.0 %

Bias Results					
Standard	Cal.	Bias	Difference	Error	Status
Gas	%	%	%	%	
Zero	0.0	0.0	0.0	0.0	Pass
Span	12.1	12.1	0.0	0.0	Pass

Calibration Drift					
Standard	Initial*	Final	Difference	Drift	Status
Gas	%	%	%	%	
Zero	0.0	0.0	0.0	0.0	Pass
Span	12.2	12.1	-0.1	-0.5	Pass

*Bias No. 9

CO₂
Method: EPA 3A
Span Conc. 16.6 %

Bias Results					
Standard	Cal.	Bias	Difference	Error	Status
Gas	%	%	%	%	
Zero	0.0	0.0	0.0	0.0	Pass
Span	8.6	8.3	-0.3	-1.8	Pass

Calibration Drift					
Standard	Initial*	Final	Difference	Drift	Status
Gas	%	%	%	%	
Zero	0.0	0.0	0.0	0.0	Pass
Span	8.4	8.3	-0.1	-0.6	Pass

*Bias No. 9

APPENDIX C
LABORATORY ANALYTICAL REPORT

Note: The analytical report is included on the attached CD.

Client Sample Results

Client: Chemours Company FC, LLC The
Project/Site: Division Stack and Blower Intake

Job ID: 140-14453-3

Client Sample ID: Q-2275,2276 R1 DIV STACK M0010 FH

Lab Sample ID: 140-14453-9

Date Collected: 02/26/19 00:00

Matrix: Air

Date Received: 02/27/19 16:30

Sample Container: Air Train

Method: 8321A - PFOA and PFOS

Analyte	Result	Qualifier	RL	MDL	Unit	D	Prepared	Analyzed	Dil Fac
HFPO-DA	196		2.51	0.271	ug/Sample		03/04/19 13:06	03/08/19 12:53	20

Surrogate	%Recovery	Qualifier	Limits	Prepared	Analyzed	Dil Fac
13C3 HFPO-DA	99	D	50 - 200	03/04/19 13:06	03/08/19 12:53	20

Client Sample ID: Q-2277,2278,2280 R1 DIV STACK M0010

Lab Sample ID: 140-14453-10

BH

Date Collected: 02/26/19 00:00

Matrix: Air

Date Received: 02/27/19 16:30

Sample Container: Air Train

Method: 8321A - PFOA and PFOS

Analyte	Result	Qualifier	RL	MDL	Unit	D	Prepared	Analyzed	Dil Fac
HFPO-DA	1460		20.0	4.00	ug/Sample		03/04/19 05:45	03/08/19 15:07	100

Surrogate	%Recovery	Qualifier	Limits	Prepared	Analyzed	Dil Fac
13C3 HFPO-DA	80	D	50 - 200	03/04/19 05:45	03/08/19 15:07	100

Client Sample ID: Q-2279 R1 DIV STACK M0010 IMP 1,2&3

Lab Sample ID: 140-14453-11

COND

Date Collected: 02/26/19 00:00

Matrix: Air

Date Received: 02/27/19 16:30

Sample Container: Air Train

Method: 8321A - HFPO-DA

Analyte	Result	Qualifier	RL	MDL	Unit	D	Prepared	Analyzed	Dil Fac
HFPO-DA	ND		0.194	0.00989	ug/Sample		03/06/19 06:51	03/08/19 13:35	1

Surrogate	%Recovery	Qualifier	Limits	Prepared	Analyzed	Dil Fac
13C3 HFPO-DA	105		50 - 200	03/06/19 06:51	03/08/19 13:35	1

Client Sample ID: Q-2281 R1 DIV STACK M0010

Lab Sample ID: 140-14453-12

BREAKTHROUGH XAD-2 RESIN TUBE

Date Collected: 02/26/19 00:00

Matrix: Air

Date Received: 02/27/19 16:30

Sample Container: Air Train

Method: 8321A - PFOA and PFOS

Analyte	Result	Qualifier	RL	MDL	Unit	D	Prepared	Analyzed	Dil Fac
HFPO-DA	ND		0.200	0.0400	ug/Sample		03/04/19 05:45	03/08/19 15:10	1

Surrogate	%Recovery	Qualifier	Limits	Prepared	Analyzed	Dil Fac
13C3 HFPO-DA	46	X	50 - 200	03/04/19 05:45	03/08/19 15:10	1

Client Sample Results

Client: Chemours Company FC, LLC The
Project/Site: Division Stack and Blower Intake

Job ID: 140-14453-3

Client Sample ID: E-1410,1411 R1 DIV STACK INTAKE

Lab Sample ID: 140-14453-13

BLOWER M0010 FH

Date Collected: 02/26/19 00:00

Matrix: Air

Date Received: 02/27/19 16:30

Sample Container: Air Train

Method: 8321A - PFOA and PFOS

Analyte	Result	Qualifier	RL	MDL	Unit	D	Prepared	Analyzed	Dil Fac
HFPO-DA	0.797		0.0510	0.00551	ug/Sample		03/04/19 13:06	03/08/19 12:56	1
<i>Surrogate</i>	<i>%Recovery</i>	<i>Qualifier</i>	<i>Limits</i>				<i>Prepared</i>	<i>Analyzed</i>	<i>Dil Fac</i>
13C3 HFPO-DA	84		50 - 200				03/04/19 13:06	03/08/19 12:56	1

Client Sample ID: E-1412,1413,1415 R1 DIV STACK INTAKE

Lab Sample ID: 140-14453-14

BLOWER M0010 BH

Date Collected: 02/26/19 00:00

Matrix: Air

Date Received: 02/27/19 16:30

Sample Container: Air Train

Method: 8321A - PFOA and PFOS

Analyte	Result	Qualifier	RL	MDL	Unit	D	Prepared	Analyzed	Dil Fac
HFPO-DA	0.0694	J	0.200	0.0400	ug/Sample		03/04/19 05:45	03/08/19 15:13	1
<i>Surrogate</i>	<i>%Recovery</i>	<i>Qualifier</i>	<i>Limits</i>				<i>Prepared</i>	<i>Analyzed</i>	<i>Dil Fac</i>
13C3 HFPO-DA	75		50 - 200				03/04/19 05:45	03/08/19 15:13	1

Client Sample ID: E-1414 R1 DIV STACK INTAKE BLOWER

Lab Sample ID: 140-14453-15

M0010 IMP 1,2&3 COND

Date Collected: 02/26/19 00:00

Matrix: Air

Date Received: 02/27/19 16:30

Sample Container: Air Train

Method: 8321A - HFPO-DA

Analyte	Result	Qualifier	RL	MDL	Unit	D	Prepared	Analyzed	Dil Fac
HFPO-DA	0.0486	J	0.200	0.0102	ug/Sample		03/06/19 06:51	03/08/19 13:42	1
<i>Surrogate</i>	<i>%Recovery</i>	<i>Qualifier</i>	<i>Limits</i>				<i>Prepared</i>	<i>Analyzed</i>	<i>Dil Fac</i>
13C3 HFPO-DA	100		50 - 200				03/06/19 06:51	03/08/19 13:42	1

Client Sample ID: E-1416 R1 DIV STACK INTAKE BLOWER

Lab Sample ID: 140-14453-16

M0010 BREAKTHROUGH XAD-2 RESIN TUBE

Date Collected: 02/26/19 00:00

Matrix: Air

Date Received: 02/27/19 16:30

Sample Container: Air Train

Method: 8321A - PFOA and PFOS

Analyte	Result	Qualifier	RL	MDL	Unit	D	Prepared	Analyzed	Dil Fac
HFPO-DA	ND		0.200	0.0400	ug/Sample		03/04/19 05:45	03/08/19 15:17	1
<i>Surrogate</i>	<i>%Recovery</i>	<i>Qualifier</i>	<i>Limits</i>				<i>Prepared</i>	<i>Analyzed</i>	<i>Dil Fac</i>
13C3 HFPO-DA	81		50 - 200				03/04/19 05:45	03/08/19 15:17	1

Client Sample Results

Client: Chemours Company FC, LLC The
Project/Site: Division Stack and Blower Intake

Job ID: 140-14453-3

Client Sample ID: K-1760,1761 R4 DIV STACK M0010 FH

Lab Sample ID: 140-14453-25

Date Collected: 02/27/19 00:00

Matrix: Air

Date Received: 02/27/19 16:30

Sample Container: Air Train

Method: 8321A - PFOA and PFOS

Analyte	Result	Qualifier	RL	MDL	Unit	D	Prepared	Analyzed	Dil Fac
HFPO-DA	119		1.26	0.136	ug/Sample		03/07/19 09:38	03/11/19 13:01	10

Surrogate	%Recovery	Qualifier	Limits	Prepared	Analyzed	Dil Fac
13C3 HFPO-DA	120	D	50 - 200	03/07/19 09:38	03/11/19 13:01	10

Client Sample ID: K-1762,1763,1765 R4 DIV STACK M0010 BH

Lab Sample ID: 140-14453-26

Date Collected: 02/27/19 00:00

Matrix: Air

Date Received: 02/27/19 16:30

Sample Container: Air Train

Method: 8321A - PFOA and PFOS

Analyte	Result	Qualifier	RL	MDL	Unit	D	Prepared	Analyzed	Dil Fac
HFPO-DA	1580		10.0	2.00	ug/Sample		03/06/19 08:09	03/18/19 10:09	50

Surrogate	%Recovery	Qualifier	Limits	Prepared	Analyzed	Dil Fac
13C3 HFPO-DA	94	D	50 - 200	03/06/19 08:09	03/18/19 10:09	50

Client Sample ID: K-1764 R4 DIV STACK M0010 IMP 1,2&3

Lab Sample ID: 140-14453-27

COND

Date Collected: 02/27/19 00:00

Matrix: Air

Date Received: 02/27/19 16:30

Sample Container: Air Train

Method: 8321A - HFPO-DA

Analyte	Result	Qualifier	RL	MDL	Unit	D	Prepared	Analyzed	Dil Fac
HFPO-DA	0.0800	J	0.206	0.0105	ug/Sample		03/06/19 06:51	03/08/19 13:55	1

Surrogate	%Recovery	Qualifier	Limits	Prepared	Analyzed	Dil Fac
13C3 HFPO-DA	91		50 - 200	03/06/19 06:51	03/08/19 13:55	1

Client Sample ID: K-1766 R4 DIV STACK M0010

Lab Sample ID: 140-14453-28

BREAKTHROUGH XAD-2 RESIN TUBE

Date Collected: 02/27/19 00:00

Matrix: Air

Date Received: 02/27/19 16:30

Sample Container: Air Train

Method: 8321A - PFOA and PFOS

Analyte	Result	Qualifier	RL	MDL	Unit	D	Prepared	Analyzed	Dil Fac
HFPO-DA	ND		0.200	0.0400	ug/Sample		03/06/19 08:09	03/18/19 10:12	1

Surrogate	%Recovery	Qualifier	Limits	Prepared	Analyzed	Dil Fac
13C3 HFPO-DA	29	X	50 - 200	03/06/19 08:09	03/18/19 10:12	1

Client Sample Results

Client: Chemours Company FC, LLC The
Project/Site: Division Stack and Blower Intake

Job ID: 140-14453-3

Client Sample ID: E-1663,1664 R4 DIV STACK INTAKE

Lab Sample ID: 140-14453-29

BLOWER M0010 FH

Date Collected: 02/27/19 00:00

Matrix: Air

Date Received: 02/27/19 16:30

Sample Container: Air Train

Method: 8321A - PFOA and PFOS

Analyte	Result	Qualifier	RL	MDL	Unit	D	Prepared	Analyzed	Dil Fac
HFPO-DA	0.286		0.0765	0.00826	ug/Sample		03/07/19 09:38	03/11/19 13:07	1
<i>Surrogate</i>	<i>%Recovery</i>	<i>Qualifier</i>	<i>Limits</i>				<i>Prepared</i>	<i>Analyzed</i>	<i>Dil Fac</i>
13C3 HFPO-DA	127		50 - 200				03/07/19 09:38	03/11/19 13:07	1

Client Sample ID: E-1665,1666,1668 R4 DIV STACK INTAKE

Lab Sample ID: 140-14453-30

BLOWER M0010 BH

Date Collected: 02/27/19 00:00

Matrix: Air

Date Received: 02/27/19 16:30

Sample Container: Air Train

Method: 8321A - PFOA and PFOS

Analyte	Result	Qualifier	RL	MDL	Unit	D	Prepared	Analyzed	Dil Fac
HFPO-DA	0.153	J	0.200	0.0400	ug/Sample		03/06/19 08:09	03/18/19 10:15	1
<i>Surrogate</i>	<i>%Recovery</i>	<i>Qualifier</i>	<i>Limits</i>				<i>Prepared</i>	<i>Analyzed</i>	<i>Dil Fac</i>
13C3 HFPO-DA	72		50 - 200				03/06/19 08:09	03/18/19 10:15	1

Client Sample ID: E-1667 R4 DIV STACK INTAKE BLOWER

Lab Sample ID: 140-14453-31

M0010 IMP 1,2&3 COND

Date Collected: 02/27/19 00:00

Matrix: Air

Date Received: 02/27/19 16:30

Sample Container: Air Train

Method: 8321A - HFPO-DA

Analyte	Result	Qualifier	RL	MDL	Unit	D	Prepared	Analyzed	Dil Fac
HFPO-DA	0.0880	J	0.218	0.0111	ug/Sample		03/06/19 06:51	03/08/19 14:01	1
<i>Surrogate</i>	<i>%Recovery</i>	<i>Qualifier</i>	<i>Limits</i>				<i>Prepared</i>	<i>Analyzed</i>	<i>Dil Fac</i>
13C3 HFPO-DA	103		50 - 200				03/06/19 06:51	03/08/19 14:01	1

Client Sample ID: E-1669 R4 DIV STACK INTAKE BLOWER

Lab Sample ID: 140-14453-32

M0010 BREAKTHROUGH XAD-2 RESIN TUBE

Date Collected: 02/27/19 00:00

Matrix: Air

Date Received: 02/27/19 16:30

Sample Container: Air Train

Method: 8321A - PFOA and PFOS

Analyte	Result	Qualifier	RL	MDL	Unit	D	Prepared	Analyzed	Dil Fac
HFPO-DA	ND		0.200	0.0400	ug/Sample		03/06/19 08:09	03/18/19 10:19	1
<i>Surrogate</i>	<i>%Recovery</i>	<i>Qualifier</i>	<i>Limits</i>				<i>Prepared</i>	<i>Analyzed</i>	<i>Dil Fac</i>
13C3 HFPO-DA	79		50 - 200				03/06/19 08:09	03/18/19 10:19	1

Client Sample Results

Client: Chemours Company FC, LLC The
Project/Site: Division Stack and Blower Intake

Job ID: 140-14453-3

Client Sample ID: Q-2282,2283 R3 DIV STACK M0010 FH

Lab Sample ID: 140-14459-9

Date Collected: 02/27/19 00:00

Matrix: Air

Date Received: 02/27/19 16:30

Sample Container: Air Train

Method: 8321A - PFOA and PFOS

Analyte	Result	Qualifier	RL	MDL	Unit	D	Prepared	Analyzed	Dil Fac
HFPO-DA	61.7		1.26	0.136	ug/Sample		03/07/19 09:38	03/11/19 13:17	10

Surrogate	%Recovery	Qualifier	Limits	Prepared	Analyzed	Dil Fac
13C3 HFPO-DA	121	D	50 - 200	03/07/19 09:38	03/11/19 13:17	10

Client Sample ID: Q-2284,2285,2287 R3 DIV STACK M0010 BH

Lab Sample ID: 140-14459-10

Date Collected: 02/27/19 00:00

Matrix: Air

Date Received: 02/27/19 16:30

Sample Container: Air Train

Method: 8321A - PFOA and PFOS

Analyte	Result	Qualifier	RL	MDL	Unit	D	Prepared	Analyzed	Dil Fac
HFPO-DA	92.9		2.00	0.400	ug/Sample		03/06/19 08:09	03/18/19 10:38	10

Surrogate	%Recovery	Qualifier	Limits	Prepared	Analyzed	Dil Fac
13C3 HFPO-DA	66	D	50 - 200	03/06/19 08:09	03/18/19 10:38	10

Client Sample ID: Q-2286 R3 DIV STACK M0010 IMP 1,2&3

Lab Sample ID: 140-14459-11

COND

Date Collected: 02/27/19 00:00

Matrix: Air

Date Received: 02/27/19 16:30

Sample Container: Air Train

Method: 8321A - HFPO-DA

Analyte	Result	Qualifier	RL	MDL	Unit	D	Prepared	Analyzed	Dil Fac
HFPO-DA	ND		0.200	0.0102	ug/Sample		03/06/19 11:22	03/11/19 12:09	1

Surrogate	%Recovery	Qualifier	Limits	Prepared	Analyzed	Dil Fac
13C3 HFPO-DA	124		50 - 200	03/06/19 11:22	03/11/19 12:09	1

Client Sample ID: Q-2288 R3 DIV STACK M0010

Lab Sample ID: 140-14459-12

BREAKTHROUGH XAD-2 RESIN TUBE

Date Collected: 02/27/19 00:00

Matrix: Air

Date Received: 02/27/19 16:30

Sample Container: Air Train

Method: 8321A - PFOA and PFOS

Analyte	Result	Qualifier	RL	MDL	Unit	D	Prepared	Analyzed	Dil Fac
HFPO-DA	ND		0.200	0.0400	ug/Sample		03/06/19 08:09	03/18/19 10:41	1

Surrogate	%Recovery	Qualifier	Limits	Prepared	Analyzed	Dil Fac
13C3 HFPO-DA	25	X	50 - 200	03/06/19 08:09	03/18/19 10:41	1

Client Sample Results

Client: Chemours Company FC, LLC The
Project/Site: Division Stack and Blower Intake

Job ID: 140-14453-3

Client Sample ID: E-1417,1418 R3 DIV STACK INTAKE

Lab Sample ID: 140-14459-13

BLOWER M0010 FH

Date Collected: 02/27/19 00:00

Matrix: Air

Date Received: 02/27/19 16:30

Sample Container: Air Train

Method: 8321A - PFOA and PFOS

Analyte	Result	Qualifier	RL	MDL	Unit	D	Prepared	Analyzed	Dil Fac
HFPO-DA	0.339		0.101	0.0109	ug/Sample		03/07/19 09:38	03/11/19 13:20	1
<i>Surrogate</i>	<i>%Recovery</i>	<i>Qualifier</i>	<i>Limits</i>				<i>Prepared</i>	<i>Analyzed</i>	<i>Dil Fac</i>
13C3 HFPO-DA	124		50 - 200				03/07/19 09:38	03/11/19 13:20	1

Client Sample ID: E-1419,1420,1422 R3 DIV STACK INTAKE

Lab Sample ID: 140-14459-14

BLOWER M0010 BH

Date Collected: 02/27/19 00:00

Matrix: Air

Date Received: 02/27/19 16:30

Sample Container: Air Train

Method: 8321A - PFOA and PFOS

Analyte	Result	Qualifier	RL	MDL	Unit	D	Prepared	Analyzed	Dil Fac
HFPO-DA	0.251		0.200	0.0400	ug/Sample		03/06/19 08:09	03/18/19 10:48	1
<i>Surrogate</i>	<i>%Recovery</i>	<i>Qualifier</i>	<i>Limits</i>				<i>Prepared</i>	<i>Analyzed</i>	<i>Dil Fac</i>
13C3 HFPO-DA	81		50 - 200				03/06/19 08:09	03/18/19 10:48	1

Client Sample ID: E-1421 R3 DIV STACK INTAKE BLOWER

Lab Sample ID: 140-14459-15

M0010 IMP 1,2&3 COND

Date Collected: 02/27/19 00:00

Matrix: Air

Date Received: 02/27/19 16:30

Sample Container: Air Train

Method: 8321A - HFPO-DA

Analyte	Result	Qualifier	RL	MDL	Unit	D	Prepared	Analyzed	Dil Fac
HFPO-DA	0.0704	J	0.210	0.0107	ug/Sample		03/06/19 11:22	03/11/19 12:12	1
<i>Surrogate</i>	<i>%Recovery</i>	<i>Qualifier</i>	<i>Limits</i>				<i>Prepared</i>	<i>Analyzed</i>	<i>Dil Fac</i>
13C3 HFPO-DA	131		50 - 200				03/06/19 11:22	03/11/19 12:12	1

Client Sample ID: E-1423 R3 DIV STACK INTAKE BLOWER

Lab Sample ID: 140-14459-16

M0010 BREAKTHROUGH XAD-2 RESIN TUBE

Date Collected: 02/27/19 00:00

Matrix: Air

Date Received: 02/27/19 16:30

Sample Container: Air Train

Method: 8321A - PFOA and PFOS

Analyte	Result	Qualifier	RL	MDL	Unit	D	Prepared	Analyzed	Dil Fac
HFPO-DA	ND		0.200	0.0400	ug/Sample		03/06/19 08:09	03/18/19 10:51	1
<i>Surrogate</i>	<i>%Recovery</i>	<i>Qualifier</i>	<i>Limits</i>				<i>Prepared</i>	<i>Analyzed</i>	<i>Dil Fac</i>
13C3 HFPO-DA	86		50 - 200				03/06/19 08:09	03/18/19 10:51	1

Client Sample Results

Client: Chemours Company FC, LLC The
Project/Site: Division Stack and Blower Intake

Job ID: 140-14453-3

Client Sample ID: K-1753,1754 DIV STACK M0010 R2 FH 230

Lab Sample ID: 140-14464-9

KG/HR

Date Collected: 02/26/19 00:00

Matrix: Air

Date Received: 03/02/19 09:30

Sample Container: Air Train

Method: 8321A - PFOA and PFOS

Analyte	Result	Qualifier	RL	MDL	Unit	D	Prepared	Analyzed	Dil Fac
HFPO-DA	96.5		1.51	0.163	ug/Sample		03/04/19 13:06	03/08/19 13:16	10
<i>Surrogate</i>	<i>%Recovery</i>	<i>Qualifier</i>	<i>Limits</i>				<i>Prepared</i>	<i>Analyzed</i>	<i>Dil Fac</i>
13C3 HFPO-DA	103	D	50 - 200				03/04/19 13:06	03/08/19 13:16	10

Client Sample ID: K-1755,1756,1758 DIV STACK M0010 R2 BH

Lab Sample ID: 140-14464-10

230 KG/HR

Date Collected: 02/26/19 00:00

Matrix: Air

Date Received: 03/02/19 09:30

Sample Container: Air Train

Method: 8321A - PFOA and PFOS

Analyte	Result	Qualifier	RL	MDL	Unit	D	Prepared	Analyzed	Dil Fac
HFPO-DA	125		2.00	0.400	ug/Sample		03/04/19 05:54	03/08/19 15:43	10
<i>Surrogate</i>	<i>%Recovery</i>	<i>Qualifier</i>	<i>Limits</i>				<i>Prepared</i>	<i>Analyzed</i>	<i>Dil Fac</i>
13C3 HFPO-DA	69	D	50 - 200				03/04/19 05:54	03/08/19 15:43	10

Client Sample ID: K-1757 DIV STACK M0010 R2 IMP 1,2&3

Lab Sample ID: 140-14464-11

COND 230 KG/HR

Date Collected: 02/26/19 00:00

Matrix: Air

Date Received: 03/02/19 09:30

Sample Container: Air Train

Method: 8321A - HFPO-DA

Analyte	Result	Qualifier	RL	MDL	Unit	D	Prepared	Analyzed	Dil Fac
HFPO-DA	0.216		0.194	0.00989	ug/Sample		03/06/19 06:51	03/08/19 14:14	1
<i>Surrogate</i>	<i>%Recovery</i>	<i>Qualifier</i>	<i>Limits</i>				<i>Prepared</i>	<i>Analyzed</i>	<i>Dil Fac</i>
13C3 HFPO-DA	104		50 - 200				03/06/19 06:51	03/08/19 14:14	1

Client Sample ID: K-1759 DIV STACK M0010 R2

Lab Sample ID: 140-14464-12

BREAKTHROUGH XAD-2 RESIN TUBE 230 KG/HR

Date Collected: 02/26/19 00:00

Matrix: Air

Date Received: 03/02/19 09:30

Sample Container: Air Train

Method: 8321A - PFOA and PFOS

Analyte	Result	Qualifier	RL	MDL	Unit	D	Prepared	Analyzed	Dil Fac
HFPO-DA	ND		0.200	0.0400	ug/Sample		03/04/19 05:54	03/08/19 15:46	1
<i>Surrogate</i>	<i>%Recovery</i>	<i>Qualifier</i>	<i>Limits</i>				<i>Prepared</i>	<i>Analyzed</i>	<i>Dil Fac</i>
13C3 HFPO-DA	51		50 - 200				03/04/19 05:54	03/08/19 15:46	1

Client Sample Results

Client: Chemours Company FC, LLC The
Project/Site: Division Stack and Blower Intake

Job ID: 140-14453-3

Client Sample ID: E-1656,1657 DIV STACK INTAKE BLOWER

Lab Sample ID: 140-14464-13

M0010 R2 FH 230 KG/HR

Date Collected: 02/26/19 00:00

Matrix: Air

Date Received: 03/02/19 09:30

Sample Container: Air Train

Method: 8321A - PFOA and PFOS

Analyte	Result	Qualifier	RL	MDL	Unit	D	Prepared	Analyzed	Dil Fac
HFPO-DA	0.298		0.126	0.0136	ug/Sample		03/04/19 13:06	03/08/19 13:19	1
<i>Surrogate</i>	<i>%Recovery</i>	<i>Qualifier</i>	<i>Limits</i>				<i>Prepared</i>	<i>Analyzed</i>	<i>Dil Fac</i>
13C3 HFPO-DA	103		50 - 200				03/04/19 13:06	03/08/19 13:19	1

Client Sample ID: E-1658,1659,1661 DIV STACK INTAKE

Lab Sample ID: 140-14464-14

BLOWER M0010 R2 BH 230 KG/HR

Date Collected: 02/26/19 00:00

Matrix: Air

Date Received: 03/02/19 09:30

Sample Container: Air Train

Method: 8321A - PFOA and PFOS

Analyte	Result	Qualifier	RL	MDL	Unit	D	Prepared	Analyzed	Dil Fac
HFPO-DA	0.0846	J	0.200	0.0400	ug/Sample		03/04/19 05:54	03/08/19 15:49	1
<i>Surrogate</i>	<i>%Recovery</i>	<i>Qualifier</i>	<i>Limits</i>				<i>Prepared</i>	<i>Analyzed</i>	<i>Dil Fac</i>
13C3 HFPO-DA	76		50 - 200				03/04/19 05:54	03/08/19 15:49	1

Client Sample ID: E-1660 DIV STACK INTAKE BLOWER M0010

Lab Sample ID: 140-14464-15

R2 IMP 1,2&3 COND 230 KG/HR

Date Collected: 02/26/19 00:00

Matrix: Air

Date Received: 03/02/19 09:30

Sample Container: Air Train

Method: 8321A - HFPO-DA

Analyte	Result	Qualifier	RL	MDL	Unit	D	Prepared	Analyzed	Dil Fac
HFPO-DA	ND		0.182	0.00928	ug/Sample		03/06/19 06:51	03/08/19 14:18	1
<i>Surrogate</i>	<i>%Recovery</i>	<i>Qualifier</i>	<i>Limits</i>				<i>Prepared</i>	<i>Analyzed</i>	<i>Dil Fac</i>
13C3 HFPO-DA	110		50 - 200				03/06/19 06:51	03/08/19 14:18	1

Client Sample ID: E-1662 DIV STACK INTAKE BLOWER M0010

Lab Sample ID: 140-14464-16

R2 BREAKTHROUGH XAD-2 RESIN TUBE 230 KG/HR

Date Collected: 02/26/19 00:00

Matrix: Air

Date Received: 03/02/19 09:30

Sample Container: Air Train

Method: 8321A - PFOA and PFOS

Analyte	Result	Qualifier	RL	MDL	Unit	D	Prepared	Analyzed	Dil Fac
HFPO-DA	ND		0.200	0.0400	ug/Sample		03/04/19 05:54	03/08/19 15:53	1
<i>Surrogate</i>	<i>%Recovery</i>	<i>Qualifier</i>	<i>Limits</i>				<i>Prepared</i>	<i>Analyzed</i>	<i>Dil Fac</i>
13C3 HFPO-DA	81		50 - 200				03/04/19 05:54	03/08/19 15:53	1

Client Sample Results

Client: Chemours Company FC, LLC The
Project/Site: Division Stack and Blower Intake

Job ID: 140-14453-3

Client Sample ID: H-2684,2685 DIV STACK M0010 R6 FH 150

Lab Sample ID: 140-14464-33

KG/HR

Date Collected: 02/28/19 00:00

Matrix: Air

Date Received: 03/02/19 09:30

Sample Container: Air Train

Method: 8321A - PFOA and PFOS

Analyte	Result	Qualifier	RL	MDL	Unit	D	Prepared	Analyzed	Dil Fac
HFPO-DA	132		1.51	0.163	ug/Sample		03/07/19 09:38	03/11/19 13:43	10
<i>Surrogate</i>	<i>%Recovery</i>	<i>Qualifier</i>	<i>Limits</i>				<i>Prepared</i>	<i>Analyzed</i>	<i>Dil Fac</i>
13C3 HFPO-DA	111	D	50 - 200				03/07/19 09:38	03/11/19 13:43	10

Client Sample ID: H-2686,2687,2689 DIV STACK M0010 R6 BH

Lab Sample ID: 140-14464-34

150 KG/HR

Date Collected: 02/28/19 00:00

Matrix: Air

Date Received: 03/02/19 09:30

Sample Container: Air Train

Method: 8321A - PFOA and PFOS

Analyte	Result	Qualifier	RL	MDL	Unit	D	Prepared	Analyzed	Dil Fac
HFPO-DA	466		10.0	2.00	ug/Sample		03/06/19 08:09	03/18/19 11:07	50
<i>Surrogate</i>	<i>%Recovery</i>	<i>Qualifier</i>	<i>Limits</i>				<i>Prepared</i>	<i>Analyzed</i>	<i>Dil Fac</i>
13C3 HFPO-DA	198	D	50 - 200				03/06/19 08:09	03/18/19 11:07	50

Client Sample ID: H-2688 DIV STACK M0010 R6 IMP 1,2&3

Lab Sample ID: 140-14464-35

COND 150 KG/HR

Date Collected: 02/28/19 00:00

Matrix: Air

Date Received: 03/02/19 09:30

Sample Container: Air Train

Method: 8321A - HFPO-DA

Analyte	Result	Qualifier	RL	MDL	Unit	D	Prepared	Analyzed	Dil Fac
HFPO-DA	0.0434	J	0.200	0.0102	ug/Sample		03/06/19 06:51	03/08/19 14:37	1
<i>Surrogate</i>	<i>%Recovery</i>	<i>Qualifier</i>	<i>Limits</i>				<i>Prepared</i>	<i>Analyzed</i>	<i>Dil Fac</i>
13C3 HFPO-DA	98		50 - 200				03/06/19 06:51	03/08/19 14:37	1

Client Sample ID: H-2690 DIV STACK M0010 R6

Lab Sample ID: 140-14464-36

BREAKTHROUGH XAD-2 RESIN TUBE 150 KG/HR

Date Collected: 02/28/19 00:00

Matrix: Air

Date Received: 03/02/19 09:30

Sample Container: Air Train

Method: 8321A - PFOA and PFOS

Analyte	Result	Qualifier	RL	MDL	Unit	D	Prepared	Analyzed	Dil Fac
HFPO-DA	ND		0.200	0.0400	ug/Sample		03/06/19 08:09	03/18/19 11:14	1
<i>Surrogate</i>	<i>%Recovery</i>	<i>Qualifier</i>	<i>Limits</i>				<i>Prepared</i>	<i>Analyzed</i>	<i>Dil Fac</i>
13C3 HFPO-DA	43	X	50 - 200				03/06/19 08:09	03/18/19 11:14	1

Client Sample Results

Client: Chemours Company FC, LLC The
Project/Site: Division Stack and Blower Intake

Job ID: 140-14453-3

Client Sample ID: H-2691,2692 DIV STACK M0010 R8 FH 150

Lab Sample ID: 140-14464-37

KG/HR

Date Collected: 03/01/19 00:00

Matrix: Air

Date Received: 03/02/19 09:30

Sample Container: Air Train

Method: 8321A - PFOA and PFOS

Analyte	Result	Qualifier	RL	MDL	Unit	D	Prepared	Analyzed	Dil Fac
HFPO-DA	80.3		1.26	0.136	ug/Sample		03/07/19 09:38	03/11/19 13:46	10
<i>Surrogate</i>	<i>%Recovery</i>	<i>Qualifier</i>	<i>Limits</i>				<i>Prepared</i>	<i>Analyzed</i>	<i>Dil Fac</i>
13C3 HFPO-DA	117	D	50 - 200				03/07/19 09:38	03/11/19 13:46	10

Client Sample ID: H-2693,2694,2696 DIV STACK M0010 R8 BH

Lab Sample ID: 140-14464-38

150 KG/HR

Date Collected: 03/01/19 00:00

Matrix: Air

Date Received: 03/02/19 09:30

Sample Container: Air Train

Method: 8321A - PFOA and PFOS

Analyte	Result	Qualifier	RL	MDL	Unit	D	Prepared	Analyzed	Dil Fac
HFPO-DA	167		2.00	0.400	ug/Sample		03/11/19 09:29	03/15/19 12:10	10
<i>Surrogate</i>	<i>%Recovery</i>	<i>Qualifier</i>	<i>Limits</i>				<i>Prepared</i>	<i>Analyzed</i>	<i>Dil Fac</i>
13C3 HFPO-DA	84	D	50 - 200				03/11/19 09:29	03/15/19 12:10	10

Client Sample ID: H-2695 DIV STACK M0010 R8 IMP 1,2&3

Lab Sample ID: 140-14464-39

COND150 KG/HR

Date Collected: 03/01/19 00:00

Matrix: Air

Date Received: 03/02/19 09:30

Sample Container: Air Train

Method: 8321A - HFPO-DA

Analyte	Result	Qualifier	RL	MDL	Unit	D	Prepared	Analyzed	Dil Fac
HFPO-DA	0.715		0.210	0.0107	ug/Sample		03/06/19 06:51	03/08/19 14:41	1
<i>Surrogate</i>	<i>%Recovery</i>	<i>Qualifier</i>	<i>Limits</i>				<i>Prepared</i>	<i>Analyzed</i>	<i>Dil Fac</i>
13C3 HFPO-DA	97		50 - 200				03/06/19 06:51	03/08/19 14:41	1

Client Sample ID: H-2697 DIV STACK M0010 R8

Lab Sample ID: 140-14464-40

BREAKTHROUGH XAD-2 RESIN TUBE 150 KG/HR

Date Collected: 03/01/19 00:00

Matrix: Air

Date Received: 03/02/19 09:30

Sample Container: Air Train

Method: 8321A - PFOA and PFOS

Analyte	Result	Qualifier	RL	MDL	Unit	D	Prepared	Analyzed	Dil Fac
HFPO-DA	ND		0.200	0.0400	ug/Sample		03/11/19 09:29	03/15/19 12:13	1
<i>Surrogate</i>	<i>%Recovery</i>	<i>Qualifier</i>	<i>Limits</i>				<i>Prepared</i>	<i>Analyzed</i>	<i>Dil Fac</i>
13C3 HFPO-DA	30	X	50 - 200				03/11/19 09:29	03/15/19 12:13	1

Client Sample Results

Client: Chemours Company FC, LLC The
Project/Site: Division Stack and Blower Intake

Job ID: 140-14453-3

Client Sample ID: Q-1684,1685 DIV STACK INTAKE BLOWER

Lab Sample ID: 140-14464-41

M0010 R6 FH 150 KG/HR

Date Collected: 02/28/19 00:00

Matrix: Air

Date Received: 03/02/19 09:30

Sample Container: Air Train

Method: 8321A - PFOA and PFOS

Analyte	Result	Qualifier	RL	MDL	Unit	D	Prepared	Analyzed	Dil Fac
HFPO-DA	0.293		0.101	0.0109	ug/Sample		03/07/19 09:38	03/11/19 13:49	1
<i>Surrogate</i>	<i>%Recovery</i>	<i>Qualifier</i>	<i>Limits</i>				<i>Prepared</i>	<i>Analyzed</i>	<i>Dil Fac</i>
13C3 HFPO-DA	124		50 - 200				03/07/19 09:38	03/11/19 13:49	1

Client Sample ID: Q-1686,1687,1689 DIV STACK INTAKE

Lab Sample ID: 140-14464-42

BLOWER M0010 R6 BH 150 KG/HR

Date Collected: 02/28/19 00:00

Matrix: Air

Date Received: 03/02/19 09:30

Sample Container: Air Train

Method: 8321A - PFOA and PFOS

Analyte	Result	Qualifier	RL	MDL	Unit	D	Prepared	Analyzed	Dil Fac
HFPO-DA	2.52		0.200	0.0400	ug/Sample		03/06/19 08:09	03/18/19 11:17	1
<i>Surrogate</i>	<i>%Recovery</i>	<i>Qualifier</i>	<i>Limits</i>				<i>Prepared</i>	<i>Analyzed</i>	<i>Dil Fac</i>
13C3 HFPO-DA	81		50 - 200				03/06/19 08:09	03/18/19 11:17	1

Client Sample ID: Q-1688 DIV STACK INTAKE BLOWER M0010

Lab Sample ID: 140-14464-43

R6 IMP 1,2&3 COND 150 KG/HR

Date Collected: 02/28/19 00:00

Matrix: Air

Date Received: 03/02/19 09:30

Sample Container: Air Train

Method: 8321A - HFPO-DA

Analyte	Result	Qualifier	RL	MDL	Unit	D	Prepared	Analyzed	Dil Fac
HFPO-DA	ND		0.186	0.00949	ug/Sample		03/06/19 06:51	03/08/19 13:39	1
<i>Surrogate</i>	<i>%Recovery</i>	<i>Qualifier</i>	<i>Limits</i>				<i>Prepared</i>	<i>Analyzed</i>	<i>Dil Fac</i>
13C3 HFPO-DA	114		50 - 200				03/06/19 06:51	03/08/19 13:39	1

Client Sample ID: Q-1690 DIV STACK INTAKE BLOWER M0010

Lab Sample ID: 140-14464-44

R6 BREAKTHROUGH XAD-2 RESIN TUBE 150 KG/HR

Date Collected: 02/28/19 00:00

Matrix: Air

Date Received: 03/02/19 09:30

Sample Container: Air Train

Method: 8321A - PFOA and PFOS

Analyte	Result	Qualifier	RL	MDL	Unit	D	Prepared	Analyzed	Dil Fac
HFPO-DA	0.0652	J	0.200	0.0400	ug/Sample		03/06/19 08:09	03/18/19 11:20	1
<i>Surrogate</i>	<i>%Recovery</i>	<i>Qualifier</i>	<i>Limits</i>				<i>Prepared</i>	<i>Analyzed</i>	<i>Dil Fac</i>
13C3 HFPO-DA	91		50 - 200				03/06/19 08:09	03/18/19 11:20	1

Client Sample Results

Client: Chemours Company FC, LLC The
 Project/Site: Division Stack and Blower Intake

Job ID: 140-14453-3

Client Sample ID: Q-1691,1692 DIV STACK INTAKE BLOWER

Lab Sample ID: 140-14464-45

M0010 R8 FH 150 KG/HR

Date Collected: 03/01/19 00:00

Matrix: Air

Date Received: 03/02/19 09:30

Sample Container: Air Train

Method: 8321A - PFOA and PFOS

Analyte	Result	Qualifier	RL	MDL	Unit	D	Prepared	Analyzed	Dil Fac
HFPO-DA	0.172		0.0765	0.00826	ug/Sample		03/07/19 09:38	03/11/19 13:53	1
<i>Surrogate</i>	<i>%Recovery</i>	<i>Qualifier</i>	<i>Limits</i>				<i>Prepared</i>	<i>Analyzed</i>	<i>Dil Fac</i>
13C3 HFPO-DA	123		50 - 200				03/07/19 09:38	03/11/19 13:53	1

Client Sample ID: Q-1693,1694,1696 DIV STACK INTAKE

Lab Sample ID: 140-14464-46

BLOWER M0010 R8 BH 150 KG/HR

Date Collected: 03/01/19 00:00

Matrix: Air

Date Received: 03/02/19 09:30

Sample Container: Air Train

Method: 8321A - PFOA and PFOS

Analyte	Result	Qualifier	RL	MDL	Unit	D	Prepared	Analyzed	Dil Fac
HFPO-DA	0.0729	J	0.200	0.0400	ug/Sample		03/11/19 09:29	03/15/19 12:16	1
<i>Surrogate</i>	<i>%Recovery</i>	<i>Qualifier</i>	<i>Limits</i>				<i>Prepared</i>	<i>Analyzed</i>	<i>Dil Fac</i>
13C3 HFPO-DA	99		50 - 200				03/11/19 09:29	03/15/19 12:16	1

Client Sample ID: Q-1695 DIV STACK INTAKE BLOWER M0010

Lab Sample ID: 140-14464-47

R8 IMP 1,2&3 COND 150 KG/HR

Date Collected: 03/01/19 00:00

Matrix: Air

Date Received: 03/02/19 09:30

Sample Container: Air Train

Method: 8321A - HFPO-DA

Analyte	Result	Qualifier	RL	MDL	Unit	D	Prepared	Analyzed	Dil Fac
HFPO-DA	0.0595	J	0.200	0.0102	ug/Sample		03/06/19 06:51	03/08/19 13:58	1
<i>Surrogate</i>	<i>%Recovery</i>	<i>Qualifier</i>	<i>Limits</i>				<i>Prepared</i>	<i>Analyzed</i>	<i>Dil Fac</i>
13C3 HFPO-DA	106		50 - 200				03/06/19 06:51	03/08/19 13:58	1

Client Sample ID: Q-1697 DIV STACK INTAKE BLOWER M0010

Lab Sample ID: 140-14464-48

R8 BREAKTHROUGH XAD-2 RESIN TUBE 150 KG/HR

Date Collected: 03/01/19 00:00

Matrix: Air

Date Received: 03/02/19 09:30

Sample Container: Air Train

Method: 8321A - PFOA and PFOS

Analyte	Result	Qualifier	RL	MDL	Unit	D	Prepared	Analyzed	Dil Fac
HFPO-DA	ND		0.200	0.0400	ug/Sample		03/11/19 09:29	03/15/19 12:20	1
<i>Surrogate</i>	<i>%Recovery</i>	<i>Qualifier</i>	<i>Limits</i>				<i>Prepared</i>	<i>Analyzed</i>	<i>Dil Fac</i>
13C3 HFPO-DA	109		50 - 200				03/11/19 09:29	03/15/19 12:20	1

Client Sample Results

Client: Chemours Company FC, LLC The
Project/Site: Division Stack and Blower Intake

Job ID: 140-14453-3

Client Sample ID: T-1450,1451 R5 DIV STACK M0010 FH

Lab Sample ID: 140-14468-17

Date Collected: 02/28/19 00:00

Matrix: Air

Date Received: 03/02/19 09:30

Sample Container: Air Train

Method: 8321A - PFOA and PFOS

Analyte	Result	Qualifier	RL	MDL	Unit	D	Prepared	Analyzed	Dil Fac
HFPO-DA	137		1.26	0.136	ug/Sample		03/12/19 03:13	03/15/19 13:15	10

Surrogate	%Recovery	Qualifier	Limits	Prepared	Analyzed	Dil Fac
13C3 HFPO-DA	140	D	50 - 200	03/12/19 03:13	03/15/19 13:15	10

Client Sample ID: T-1452,1453,1455 R5 DIV STACK M0010 BH

Lab Sample ID: 140-14468-18

Date Collected: 02/28/19 00:00

Matrix: Air

Date Received: 03/02/19 09:30

Sample Container: Air Train

Method: 8321A - PFOA and PFOS

Analyte	Result	Qualifier	RL	MDL	Unit	D	Prepared	Analyzed	Dil Fac
HFPO-DA	1950		20.0	4.00	ug/Sample		03/12/19 03:08	03/15/19 09:51	100

Surrogate	%Recovery	Qualifier	Limits	Prepared	Analyzed	Dil Fac
13C3 HFPO-DA	101	D	50 - 200	03/12/19 03:08	03/15/19 09:51	100

Client Sample ID: T-1454 R5 DIV STACK M0010 IMP 1,2&3

Lab Sample ID: 140-14468-19

COND

Date Collected: 02/28/19 00:00

Matrix: Air

Date Received: 03/02/19 09:30

Sample Container: Air Train

Method: 8321A - HFPO-DA

Analyte	Result	Qualifier	RL	MDL	Unit	D	Prepared	Analyzed	Dil Fac
HFPO-DA	0.244		0.194	0.00989	ug/Sample		03/06/19 11:22	03/11/19 12:41	1

Surrogate	%Recovery	Qualifier	Limits	Prepared	Analyzed	Dil Fac
13C3 HFPO-DA	115		50 - 200	03/06/19 11:22	03/11/19 12:41	1

Client Sample ID: T-1456 R5 DIV STACK M0010

Lab Sample ID: 140-14468-20

BREAKTHROUGH XAD-2 RESIN TUBE

Date Collected: 02/28/19 00:00

Matrix: Air

Date Received: 03/02/19 09:30

Sample Container: Air Train

Method: 8321A - PFOA and PFOS

Analyte	Result	Qualifier	RL	MDL	Unit	D	Prepared	Analyzed	Dil Fac
HFPO-DA	0.547		0.200	0.0400	ug/Sample		03/12/19 03:08	03/15/19 09:54	1

Surrogate	%Recovery	Qualifier	Limits	Prepared	Analyzed	Dil Fac
13C3 HFPO-DA	30	X	50 - 200	03/12/19 03:08	03/15/19 09:54	1

Client Sample ID: T-1457,1458 R7 DIV STACK M0010 FH

Lab Sample ID: 140-14468-21

Date Collected: 03/01/19 00:00

Matrix: Air

Date Received: 03/02/19 09:30

Sample Container: Air Train

Method: 8321A - PFOA and PFOS

Analyte	Result	Qualifier	RL	MDL	Unit	D	Prepared	Analyzed	Dil Fac
HFPO-DA	140		1.52	0.164	ug/Sample		03/12/19 03:13	03/15/19 13:18	20

Eurofins TestAmerica, Knoxville

Client Sample Results

Client: Chemours Company FC, LLC The
Project/Site: Division Stack and Blower Intake

Job ID: 140-14453-3

Client Sample ID: T-1457,1458 R7 DIV STACK M0010 FH

Lab Sample ID: 140-14468-21

Date Collected: 03/01/19 00:00

Matrix: Air

Date Received: 03/02/19 09:30

Sample Container: Air Train

Surrogate	%Recovery	Qualifier	Limits	Prepared	Analyzed	Dil Fac
13C3 HFPO-DA	145	D	50 - 200	03/12/19 03:13	03/15/19 13:18	20

Client Sample ID: T-1459,1460,1462 R7 DIV STACK M0010 BH

Lab Sample ID: 140-14468-22

Date Collected: 03/01/19 00:00

Matrix: Air

Date Received: 03/02/19 09:30

Sample Container: Air Train

Method: 8321A - PFOA and PFOS

Analyte	Result	Qualifier	RL	MDL	Unit	D	Prepared	Analyzed	Dil Fac
HFPO-DA	1340		10.0	2.00	ug/Sample		03/12/19 03:08	03/15/19 09:58	50

Surrogate	%Recovery	Qualifier	Limits	Prepared	Analyzed	Dil Fac
13C3 HFPO-DA	78	D	50 - 200	03/12/19 03:08	03/15/19 09:58	50

Client Sample ID: T-1461 R7 DIV STACK M0010 IMP 1,2&3

Lab Sample ID: 140-14468-23

COND

Date Collected: 03/01/19 00:00

Matrix: Air

Date Received: 03/02/19 09:30

Sample Container: Air Train

Method: 8321A - HFPO-DA

Analyte	Result	Qualifier	RL	MDL	Unit	D	Prepared	Analyzed	Dil Fac
HFPO-DA	0.235		0.192	0.00979	ug/Sample		03/06/19 11:22	03/11/19 12:44	1

Surrogate	%Recovery	Qualifier	Limits	Prepared	Analyzed	Dil Fac
13C3 HFPO-DA	107		50 - 200	03/06/19 11:22	03/11/19 12:44	1

Client Sample ID: T-1463 R7 DIV STACK M0010

Lab Sample ID: 140-14468-24

BREAKTHROUGH XAD-2 RESIN TUBE

Date Collected: 03/01/19 00:00

Matrix: Air

Date Received: 03/02/19 09:30

Sample Container: Air Train

Method: 8321A - PFOA and PFOS

Analyte	Result	Qualifier	RL	MDL	Unit	D	Prepared	Analyzed	Dil Fac
HFPO-DA	ND		0.200	0.0400	ug/Sample		03/12/19 03:08	03/15/19 10:04	1

Surrogate	%Recovery	Qualifier	Limits	Prepared	Analyzed	Dil Fac
13C3 HFPO-DA	29	X	50 - 200	03/12/19 03:08	03/15/19 10:04	1

Client Sample ID: E-2050,2051 R5 DIV INTAKE BLOWER

Lab Sample ID: 140-14468-25

M0010 FH

Date Collected: 02/28/19 00:00

Matrix: Air

Date Received: 03/02/19 09:30

Sample Container: Air Train

Method: 8321A - PFOA and PFOS

Analyte	Result	Qualifier	RL	MDL	Unit	D	Prepared	Analyzed	Dil Fac
HFPO-DA	0.164		0.126	0.0136	ug/Sample		03/12/19 03:13	03/15/19 13:21	1

Client Sample Results

Client: Chemours Company FC, LLC The
Project/Site: Division Stack and Blower Intake

Job ID: 140-14453-3

Client Sample ID: E-2050,2051 R5 DIV INTAKE BLOWER

Lab Sample ID: 140-14468-25

M0010 FH

Date Collected: 02/28/19 00:00

Matrix: Air

Date Received: 03/02/19 09:30

Sample Container: Air Train

Surrogate	%Recovery	Qualifier	Limits	Prepared	Analyzed	Dil Fac
13C3 HFPO-DA	140		50 - 200	03/12/19 03:13	03/15/19 13:21	1

Client Sample ID: E-2052,2053,2055 R5 DIV INTAKE BLOWER

Lab Sample ID: 140-14468-26

M0010 BH

Date Collected: 02/28/19 00:00

Matrix: Air

Date Received: 03/02/19 09:30

Sample Container: Air Train

Method: 8321A - PFOA and PFOS

Analyte	Result	Qualifier	RL	MDL	Unit	D	Prepared	Analyzed	Dil Fac
HFPO-DA	0.380		0.200	0.0400	ug/Sample		03/12/19 03:08	03/15/19 10:08	1

Surrogate	%Recovery	Qualifier	Limits	Prepared	Analyzed	Dil Fac
13C3 HFPO-DA	99		50 - 200	03/12/19 03:08	03/15/19 10:08	1

Client Sample ID: E-2054 R5 DIV INTAKE BLOWER M0010 IMP

Lab Sample ID: 140-14468-27

1,2&3 COND

Date Collected: 02/28/19 00:00

Matrix: Air

Date Received: 03/02/19 09:30

Sample Container: Air Train

Method: 8321A - HFPO-DA

Analyte	Result	Qualifier	RL	MDL	Unit	D	Prepared	Analyzed	Dil Fac
HFPO-DA	0.0589	J	0.202	0.0103	ug/Sample		03/06/19 11:22	03/11/19 12:48	1

Surrogate	%Recovery	Qualifier	Limits	Prepared	Analyzed	Dil Fac
13C3 HFPO-DA	132		50 - 200	03/06/19 11:22	03/11/19 12:48	1

Client Sample ID: E-2056 R5 DIV INTAKE BLOWER M0010

Lab Sample ID: 140-14468-28

BREAKTHROUGH XAD-2 RESIN TUBE

Date Collected: 02/28/19 00:00

Matrix: Air

Date Received: 03/02/19 09:30

Sample Container: Air Train

Method: 8321A - PFOA and PFOS

Analyte	Result	Qualifier	RL	MDL	Unit	D	Prepared	Analyzed	Dil Fac
HFPO-DA	ND		0.200	0.0400	ug/Sample		03/12/19 03:08	03/15/19 10:14	1

Surrogate	%Recovery	Qualifier	Limits	Prepared	Analyzed	Dil Fac
13C3 HFPO-DA	112		50 - 200	03/12/19 03:08	03/15/19 10:14	1

Client Sample Results

Client: Chemours Company FC, LLC The
Project/Site: Division Stack and Blower Intake

Job ID: 140-14453-3

Client Sample ID: E-2057,2058 R7 DIV INTAKE BLOWER

Lab Sample ID: 140-14468-29

M0010 FH

Date Collected: 03/01/19 00:00

Matrix: Air

Date Received: 03/02/19 09:30

Sample Container: Air Train

Method: 8321A - PFOA and PFOS

Analyte	Result	Qualifier	RL	MDL	Unit	D	Prepared	Analyzed	Dil Fac
HFPO-DA	0.342		0.102	0.0110	ug/Sample		03/12/19 03:13	03/15/19 13:25	1
<i>Surrogate</i>	<i>%Recovery</i>	<i>Qualifier</i>	<i>Limits</i>				<i>Prepared</i>	<i>Analyzed</i>	<i>Dil Fac</i>
13C3 HFPO-DA	150		50 - 200				03/12/19 03:13	03/15/19 13:25	1

Client Sample ID: E-2059,2060,2062 R7 DIV INTAKE BLOWER

Lab Sample ID: 140-14468-30

M0010 BH

Date Collected: 03/01/19 00:00

Matrix: Air

Date Received: 03/02/19 09:30

Sample Container: Air Train

Method: 8321A - PFOA and PFOS

Analyte	Result	Qualifier	RL	MDL	Unit	D	Prepared	Analyzed	Dil Fac
HFPO-DA	0.168	J	0.200	0.0400	ug/Sample		03/12/19 03:08	03/15/19 10:17	1
<i>Surrogate</i>	<i>%Recovery</i>	<i>Qualifier</i>	<i>Limits</i>				<i>Prepared</i>	<i>Analyzed</i>	<i>Dil Fac</i>
13C3 HFPO-DA	109		50 - 200				03/12/19 03:08	03/15/19 10:17	1

Client Sample ID: E-2061 R7 DIV INTAKE BLOWER M0010 IMP

Lab Sample ID: 140-14468-31

1,2&3 COND

Date Collected: 03/01/19 00:00

Matrix: Air

Date Received: 03/02/19 09:30

Sample Container: Air Train

Method: 8321A - HFPO-DA

Analyte	Result	Qualifier	RL	MDL	Unit	D	Prepared	Analyzed	Dil Fac
HFPO-DA	0.0920	J	0.196	0.00999	ug/Sample		03/06/19 11:22	03/11/19 12:51	1
<i>Surrogate</i>	<i>%Recovery</i>	<i>Qualifier</i>	<i>Limits</i>				<i>Prepared</i>	<i>Analyzed</i>	<i>Dil Fac</i>
13C3 HFPO-DA	122		50 - 200				03/06/19 11:22	03/11/19 12:51	1

Client Sample ID: E-2063 R7 DIV INTAKE BLOWER M0010

Lab Sample ID: 140-14468-32

BREAKTHROUGH XAD-2 RESIN TUBE

Date Collected: 03/01/19 00:00

Matrix: Air

Date Received: 03/02/19 09:30

Sample Container: Air Train

Method: 8321A - PFOA and PFOS

Analyte	Result	Qualifier	RL	MDL	Unit	D	Prepared	Analyzed	Dil Fac
HFPO-DA	0.0927	J	0.200	0.0400	ug/Sample		03/12/19 03:08	03/15/19 10:21	1
<i>Surrogate</i>	<i>%Recovery</i>	<i>Qualifier</i>	<i>Limits</i>				<i>Prepared</i>	<i>Analyzed</i>	<i>Dil Fac</i>
13C3 HFPO-DA	112		50 - 200				03/12/19 03:08	03/15/19 10:21	1

APPENDIX D
SAMPLE CALCULATIONS

**SAMPLE CALCULATIONS FOR
HFPO DIMER ACID (METHOD 0010)**

Client: Chemours
Test Number: Run 3
Test Location: Divison Stack

Plant: Fayetteville, NC
Test Date: 2/27/19
Test Period: 0840-1035

1. HFPO Dimer Acid concentration, lbs/dscf.

$$\text{Conc1} = \frac{W \times 2.2046 \times 10^{-9}}{V_m(\text{std})}$$

$$\text{Conc1} = \frac{154.6 \times 2.2046 \times 10^{-9}}{53.177}$$

$$\text{Conc1} = 6.41\text{E-}09$$

Where:

W = Weight of HFPO Dimer Acid collected in sample in ug.

Conc1 = Division Stack HFPO Dimer Acid concentration, lbs/dscf.

2.2046×10^{-9} = Conversion factor from ug to lbs.

2. HFPO Dimer Acid concentration, ug/dscm.

$$\text{Conc2} = W / (V_m(\text{std}) \times 0.02832)$$

$$\text{Conc2} = 154.6 / (53.177 \times 0.02832)$$

$$\text{Conc2} = 1.03\text{E+}02$$

Where:

Conc2 = Division Stack HFPO Dimer Acid concentration, ug/dscm.

0.02832 = Conversion factor from cubic feet to cubic meters.

3. HFPO Dimer Acid mass emission rate, lbs/hr.

$$MR1_{(Outlet)} = \text{Conc1} \times Qs(\text{std}) \times 60 \text{ min/hr}$$

$$MR1_{(Outlet)} = 6.41E-09 \times 28117 \times 60$$

$$MR1_{(Outlet)} = 1.08E-02$$

Where:

$$MR1_{(Outlet)} = \text{Division Stack HFPO Dimer Acid mass emission rate, lbs/hr.}$$

4. HFPO Dimer Acid mass emission rate, g/sec.

$$MR2_{(Outlet)} = PMR1 \times 453.59 / 3600$$

$$MR2_{(Outlet)} = 1.08E-02 \times 453.59 / 3600$$

$$MR2_{(Outlet)} = 1.36E-03$$

Where:

$$MR2_{(Outlet)} = \text{Division Stack HFPO Dimer Acid mass emission rate, g/sec.}$$

$$453.6 = \text{Conversion factor from pounds to grams.}$$

$$3600 = \text{Conversion factor from hours to seconds.}$$

**EXAMPLE CALCULATIONS FOR
VOLUMETRIC FLOW AND MOISTURE AND ISOKINETICS**

Client: Chemours
Test Number: Run 3
Test Location: Division Stack

Facility: Fayetteville, NC
Test Date: 2/27/19
Test Period: 840-1035

1. Volume of dry gas sampled at standard conditions (68 deg F, 29.92 in. Hg), dscf.

$$Vm(std) = \frac{17.64 \times Y \times Vm \times \left(Pb + \frac{\Delta H}{13.6} \right)}{(Tm + 460)}$$

$$Vm(std) = \frac{17.64 \times 1.0069 \times 51.040 \times \left(30.12 + \frac{1.011}{13.6} \right)}{54.75 + 460} = 53.177$$

Where:

$Vm(std)$ = Volume of gas sample measured by the dry gas meter, corrected to standard conditions, dscf.
 Vm = Volume of gas sample measured by the dry gas meter at meter conditions, def.
 Pb = Barometric Pressure, in Hg.
 ΔH = Average pressure drop across the orifice meter, in H₂O
 Tm = Average dry gas meter temperature, deg F.
 Y = Dry gas meter calibration factor.
 17.64 = Factor that includes ratio of standard temperature (528 deg R) to standard pressure (29.92 in. Hg), deg R/in. Hg.
 13.6 = Specific gravity of mercury.

2. Volume of water vapor in the gas sample corrected to standard conditions, scf.

$$Vw(std) = (0.04707 \times Vwc) + (0.04715 \times Wwsg)$$

$$Vw(std) = (0.04707 \times 6.0) + (0.04715 \times 12.7) = 0.88$$

Where:

$Vw(std)$ = Volume of water vapor in the gas sample corrected to standard conditions, scf.
 Vwc = Volume of liquid condensed in impingers, ml.
 $Wwsg$ = Weight of water vapor collected in silica gel, g.
 0.04707 = Factor which includes the density of water (0.002201 lb/ml), the molecular weight of water (18.0 lb/lb-mole), the ideal gas constant 21.85 (in. Hg) (ft³/lb-mole)(deg R); absolute temperature at standard conditions (528 deg R), absolute pressure at standard conditions (29.92 in. Hg), ft³/ml.
 0.04715 = Factor which includes the molecular weight of water (18.0 lb/lb-mole), the ideal gas constant 21.85 (in. Hg) (ft³/lb-mole)(deg R); absolute temperature at standard conditions (528 deg R), absolute pressure at standard conditions (29.92 in. Hg), and 453.6 g/lb, ft³/g.

3. Moisture content

$$bws = \frac{Vw(std)}{Vw(std) + Vm(std)}$$
$$bws = \frac{0.88}{0.88 + 53.177} = 0.016$$

Where:

bws = Proportion of water vapor, by volume, in the gas stream, dimensionless.

4. Mole fraction of dry gas.

$$Md = 1 - bws$$
$$Md = 1 - 0.016 = 0.984$$

Where:

Md = Mole fraction of dry gas, dimensionless.

5. Dry molecular weight of gas stream, lb/lb-mole.

$$MWd = (0.440 \times \% CO_2) + (0.320 \times \% O_2) + (0.280 \times (\% N_2 + \% CO))$$
$$MWd = (0.440 \times 0.1) + (0.320 \times 20.8) + (0.280 \times (79.1 + 0.00))$$
$$MWd = 28.85$$

Where:

MWd = Dry molecular weight, lb/lb-mole.
% CO₂ = Percent carbon dioxide by volume, dry basis.
% O₂ = Percent oxygen by volume, dry basis.
% N₂ = Percent nitrogen by volume, dry basis.
% CO = Percent carbon monoxide by volume, dry basis.
0.440 = Molecular weight of carbon dioxide, divided by 100.
0.320 = Molecular weight of oxygen, divided by 100.
0.280 = Molecular weight of nitrogen or carbon monoxide, divided by 100.

6. Actual molecular weight of gas stream (wet basis), lb/lb-mole.

$$MWs = (MWd \times Md) + (18 \times (1 - Md))$$
$$MWs = (28.85 \times 0.984) + (18 \times (1 - 0.984)) = 28.67$$

Where:

MWs = Molecular weight of wet gas, lb/lb-mole.
18 = Molecular weight of water, lb/lb-mole.

7. Average velocity of gas stream at actual conditions, ft/sec.

$$V_s = 85.49 \times C_p \times ((\Delta p)^{1/2})_{\text{avg}} \times \left(\frac{T_s (\text{avg})}{P_s \times MW_s} \right)^{1/2}$$

$$V_s = 85.49 \times 0.84 \times 1.19608 \times \left(\frac{530}{30.07 \times 28.67} \right)^{1/2} = 67.4$$

Where:

- V_s = Average gas stream velocity, ft/sec.
- 85.49 = Pitot tube constant, ft/sec x $\frac{(\text{lb/lb-mole})(\text{in. Hg})^{1/2}}{(\text{deg R})(\text{in H}_2\text{O})}$
- C_p = Pitot tube coefficient, dimensionless.
- T_s = Absolute gas stream temperature, deg R = T_s , deg F + 460.
- P_s = Absolute gas stack pressure, in. Hg. = $P_b + \frac{P(\text{static})}{13.6}$
- Δp = Velocity head of stack, in. H₂O.

8. Average gas stream volumetric flow rate at actual conditions, wacf/min.

$$Q_s(\text{act}) = 60 \times V_s \times A_s$$

$$Q_s(\text{act}) = 60 \times 67.4 \times 7.07 = 28576$$

Where:

- $Q_s(\text{act})$ = Volumetric flow rate of wet stack gas at actual conditions, wacf/min.
- A_s = Cross-sectional area of stack, ft².
- 60 = Conversion factor from seconds to minutes.

9. Average gas stream dry volumetric flow rate at standard conditions, dscf/min.

$$Q_s(\text{std}) = 17.64 \times M_d \times \frac{P_s}{T_s} \times Q_s(\text{act})$$

$$Q_s(\text{std}) = 17.64 \times 0.984 \times \frac{30.07}{530.3} \times 28576$$

$$Q_s(\text{std}) = 28117$$

Where:

- $Q_s(\text{std})$ = Volumetric flow rate of dry stack gas at standard conditions, dscf/min.

10. Isokinetic variation calculated from intermediate values, percent.

$$I = \frac{17.327 \times Ts \times Vm(std)}{Vs \times O \times Ps \times Md \times (Dn)^2}$$

$$I = \frac{17.327 \times 530 \times 53.177}{67.4 \times 96 \times 30.07 \times 0.984 \times (0.160)^2} = 99.8$$

Where:

- I = Percent of isokinetic sampling.
- O = Total sampling time, minutes.
- Dn = Diameter of nozzle, inches.
- 17.327 = Factor which includes standard temperature (528 deg R), standard pressure (29.92 in. Hg), the formula for calculating area of circle $D^{2/4}$, conversion of square feet to square inches (144), conversion of seconds to minutes (60), and conversion to percent (100), $\frac{(in. Hg)(in^2)(min)}{(deg R)(ft^2)(sec)}$

APPENDIX E
EQUIPMENT CALIBRATION RECORDS

INTERFERENCE CHECK

Date: 12/4/14-12/5/14
Analyzer Type: Servomex - O₂
Model No: 4900
Serial No: 49000-652921
Calibration Span: 21.09 %
Pollutant: 21.09% O₂ - CC418692

INTERFERENT GAS	ANALYZER RESPONSE		% OF CALIBRATION SPAN ^(a)
	INTERFERENT GAS RESPONSE (%)	INTERFERENT GAS RESPONSE, WITH BACKGROUND POLLUTANT (%)	
CO ₂ (30.17% CC199689)	0.00	-0.01	0.00
NO (445 ppm CC346681)	0.00	0.02	0.11
NO ₂ (23.78 ppm CC500749)	NA	NA	NA
N ₂ O (90.4 ppm CC352661)	0.00	0.05	0.24
CO (461.5 ppm XC006064B)	0.00	0.02	0.00
SO ₂ (451.2 ppm CC409079)	0.00	0.05	0.23
CH ₄ (453.1 ppm SG901795)	NA	NA	NA
H ₂ (552 ppm ALM048043)	0.00	0.09	0.44
HCl (45.1 ppm CC17830)	0.00	0.03	0.14
NH ₃ (9.69 ppm CC58181)	0.00	0.01	0.03
TOTAL INTERFERENCE RESPONSE			1.20
METHOD SPECIFICATION			< 2.5%

^(a) The larger of the absolute values obtained for the interferent tested with and without the pollutant present was used in summing the interferences.



 Chad Walker

INTERFERENCE CHECK

Date: 12/4/14-12/5/14
Analyzer Type: Servomex - CO₂
Model No: 4900
Serial No: 49000-652921
Calibration Span: 16.65%
Pollutant: 16.65% CO₂ - CC418692

INTERFERENT GAS	ANALYZER RESPONSE		% OF CALIBRATION SPAN ^(a)
	INTERFERENT GAS RESPONSE (%)	INTERFERENT GAS RESPONSE, WITH BACKGROUND POLLUTANT (%)	
CO ₂ (30.17% CC199689)	NA	NA	NA
NO (445 ppm CC346681)	0.00	0.02	0.10
NO ₂ (23.78 ppm CC500749)	0.00	0.00	0.02
N ₂ O (90.4 ppm CC352661)	0.00	0.01	0.04
CO (461.5 ppm XC006064B)	0.00	0.01	0.00
SO ₂ (451.2 ppm CC409079)	0.00	0.11	0.64
CH ₄ (453.1 ppm SG901795)	0.00	0.07	0.44
H ₂ (552 ppm ALM048043)	0.00	0.04	0.22
HCl (45.1 ppm CC17830)	0.10	0.06	0.60
NH ₃ (9.69 ppm CC58181)	0.00	0.02	0.14
TOTAL INTERFERENCE RESPONSE			2.19
METHOD SPECIFICATION			< 2.5%

^(a) The larger of the absolute values obtained for the interferent tested with and without the pollutant present was used in summing the interferences.

 Chad Walker

CERTIFICATE OF ANALYSIS

Grade of Product: EPA Protocol

Part Number:	E03NI79E15A00E4	Reference Number:	82-401288926-1
Cylinder Number:	CC18055	Cylinder Volume:	150.5 CF
Laboratory:	124 - Riverton (SAP) - NJ	Cylinder Pressure:	2015 PSIG
PGVP Number:	B52018	Valve Outlet:	590
Gas Code:	CO2,O2,BALN	Certification Date:	Sep 04, 2018

Expiration Date: Sep 04, 2026

Certification performed in accordance with "EPA Traceability Protocol for Assay and Certification of Gaseous Calibration Standards (May 2012)" document EPA 600/R-12/531, using the assay procedures listed. Analytical Methodology does not require correction for analytical interference. This cylinder has a total analytical uncertainty as stated below with a confidence level of 95%. There are no significant impurities which affect the use of this calibration mixture. All concentrations are on a volume/volume basis unless otherwise noted.

Do Not Use This Cylinder below 100 psig, i.e. 0.7 megapascals.

ANALYTICAL RESULTS					
Component	Requested Concentration	Actual Concentration	Protocol Method	Total Relative Uncertainty	Assay Dates
CARBON DIOXIDE	9.000 %	8.864 %	G1	+/- 0.7% NIST Traceable	09/04/2018
OXYGEN	12.00 %	12.00 %	G1	+/- 0.4% NIST Traceable	09/04/2018
NITROGEN	Balance			-	

CALIBRATION STANDARDS					
Type	Lot ID	Cylinder No	Concentration	Uncertainty	Expiration Date
NTRM	13060629	CC413730	13.359 % CARBON DIOXIDE/NITROGEN	+/- 0.6%	May 09, 2019

ANALYTICAL EQUIPMENT		
Instrument/Make/Model	Analytical Principle	Last Multipoint Calibration
Horiba VIA 510-CO2-19GYCXEG	NDIR	Aug 09, 2018
Horiba MPA 510-O2-7TWMJ041	Paramagnetic	Aug 09, 2018

Triad Data Available Upon Request



Signature on file
Approved for Release

CERTIFICATE OF ANALYSIS

Grade of Product: EPA Protocol

Part Number: E03NI62E15A0224	Reference Number: 82-401044874-1
Cylinder Number: SG9169108	Cylinder Volume: 157.2 CF
Laboratory: 124 - Riverton (SAP) - NJ	Cylinder Pressure: 2015 PSIG
PGVP Number: B52017	Valve Outlet: 590
Gas Code: CO2,O2,BALN	Certification Date: Nov 18, 2017

Expiration Date: Nov 18, 2025

Certification performed in accordance with "EPA Traceability Protocol for Assay and Certification of Gaseous Calibration Standards (May 2012)" document EPA 600/R-12/531, using the assay procedures listed. Analytical Methodology does not require correction for analytical interference. This cylinder has a total analytical uncertainty as stated below with a confidence level of 95%. There are no significant impurities which affect the use of this calibration mixture. All concentrations are on a volume/volume basis unless otherwise noted.

Do Not Use This Cylinder below 100 psig, i.e. 0.7 megapascals.

ANALYTICAL RESULTS					
Component	Requested Concentration	Actual Concentration	Protocol Method	Total Relative Uncertainty	Assay Dates
CARBON DIOXIDE	17.00 %	16.58 %	G1	+/- 0.7% NIST Traceable	11/18/2017
OXYGEN	21.00 %	21.00 %	G1	+/- 0.5% NIST Traceable	11/18/2017
NITROGEN	Balance			-	

CALIBRATION STANDARDS					
Type	Lot ID	Cylinder No	Concentration	Uncertainty	Expiration Date
NTRM	12061336	CC360792	11.002 % CARBON DIOXIDE/NITROGEN	+/- 0.6%	Jan 11, 2018
NTRM	09061415	CC273526	22.53 % OXYGEN/NITROGEN	+/- 0.4%	Mar 08, 2019

ANALYTICAL EQUIPMENT		
Instrument/Make/Model	Analytical Principle	Last Multipoint Calibration
Horiba VIA 510-CO2-19GYCXEG	NDIR	Oct 30, 2017
Horiba MPA 510-O2-7TWMJ041	Paramagnetic	Oct 27, 2017

Triad Data Available Upon Request



Signature on file
Approved for Release

Type S Pitot Tube Inspection Data Form

Pitot Tube Identification Number: P-700

If all Criteria PASS
Cp is equal to 0.84

Inspection Date 2/19/19 Individual Conducting Inspection _____ ks _____

PASS/FAIL

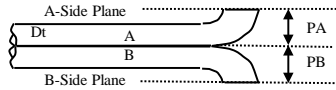

Distance to A Plane (PA) - inches 0.459
 Distance to B Plane (PB) - inches 0.459
 Pitot OD (D_t) - inches 0.375

PASS
PASS

$1.05 D_t < P < 1.5 D_t$

PA must Equal PB

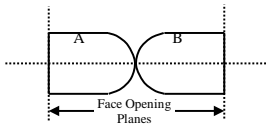

Are Open Faces Aligned Perpendicular to the Tube Axis

YES NO

PASS

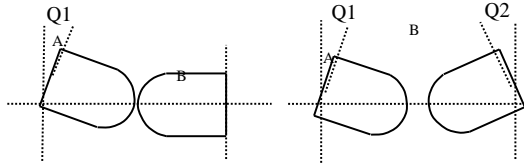

Angle of Q1 from vertical A Tube - degrees (absolute) 0

PASS

Angle of Q2 from vertical B Tube - degrees (absolute) 0

PASS

Q1 and Q2 must be $\leq 10^\circ$

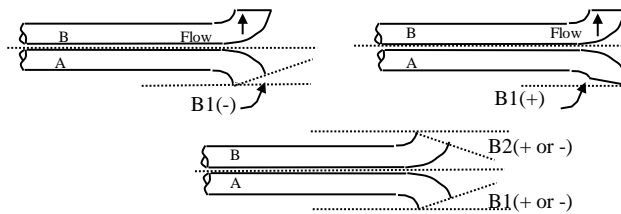

Angle of B1 from vertical A Tube - degrees (absolute) 0

PASS

Angle of B1 from vertical B Tube - degrees (absolute) 0

PASS

B1 or B2 must be $\leq 5^\circ$

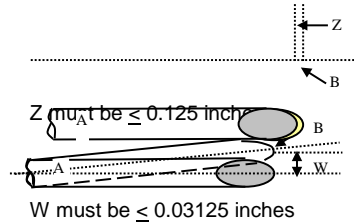

Horizontal offset between A and B Tubes (Z) - inches 0.003

PASS

Vertical offset between A and B Tubes (W) - inches 0.012

PASS

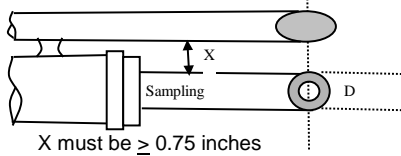

Distance between Sample Nozzle and Pitot (X) - inches 0.93

PASS

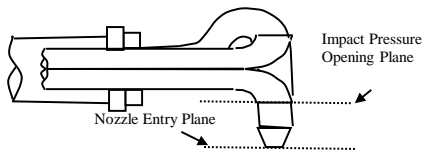

Impact Pressure Opening Plane is above the Nozzle Entry Plane

YES NO
 NA

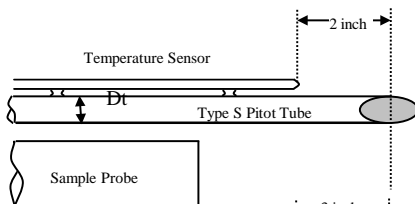

Thermocouple meets the Distance Criteria in the adjacent figure

YES NO
 NA

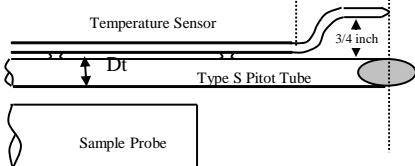

Thermocouple meets the Distance Criteria in the adjacent figure

YES NO
 NA

Type S Pitot Tube Inspection Data Form

Pitot Tube Identification Number: P-695

If all Criteria PASS
Cp is equal to 0.84

Inspection Date 2/19/19 Individual Conducting Inspection _____ ks

PASS/FAIL

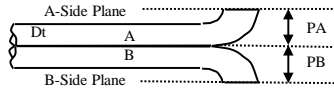

Distance to A Plane (PA) - inches 0.46
 Distance to B Plane (PB) - inches 0.46
 Pitot OD (D_t) - inches 0.375

PASS
PASS

$1.05 D_t < P < 1.5 D_t$

PA must Equal PB

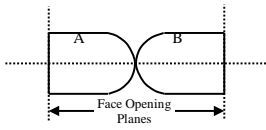

Are Open Faces Aligned
Perpendicular to the Tube Axis

YES NO

PASS

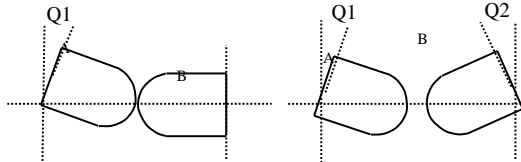

Angle of Q1 from vertical A Tube-
degrees (absolute) 0

PASS

Angle of Q2 from vertical B Tube-
degrees (absolute) 1

PASS

Q1 and Q2 must be $\leq 10^\circ$

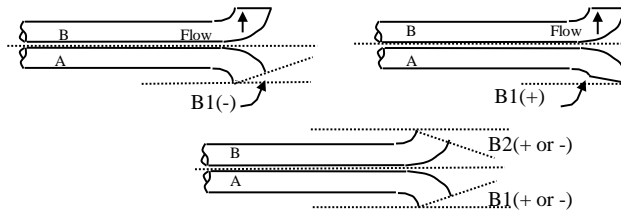

Angle of B1 from
vertical A Tube-
degrees (absolute) 0

PASS

Angle of B1 from
vertical B Tube-
degrees (absolute) 0

PASS

B1 or B2 must be $\leq 5^\circ$

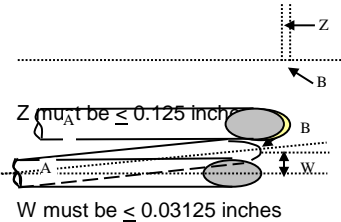

Horizontal offset between A and
B Tubes (Z) - inches 0.006

PASS

Vertical offset between A and B
Tubes (W) - inches 0.018

PASS

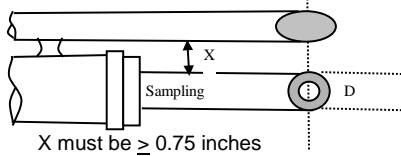

Distance between Sample
Nozzle and Pitot (X) - inches 0.78

PASS

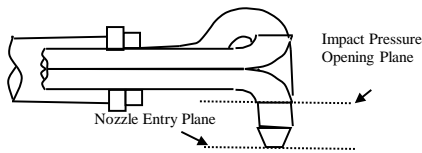

Impact Pressure
Opening Plane is
above the Nozzle
Entry Plane

YES NO
 NA

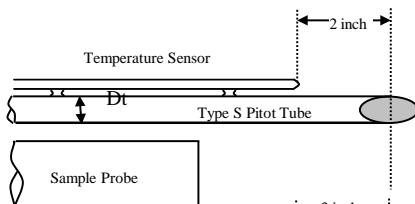

Thermocouple meets
the Distance Criteria
in the adjacent figure

YES NO
 NA

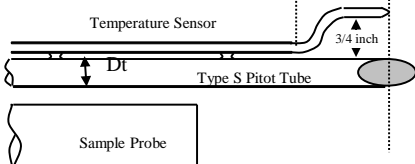

Thermocouple meets
the Distance Criteria
in the adjacent figure

YES NO
 NA

Y Factor Calibration Check Calculation

MODIFIED METHOD 0010 TEST TRAIN

DIVISION STACK

METER BOX NO. 12

2/26/2019 - 2/28/2019 & 3/1/2019

	Run 1	Run 2	Run 3
MWd = Dry molecular weight source gas, lb/lb-mole.			
0.32 = Molecular weight of oxygen, divided by 100.			
0.44 = Molecular weight of carbon dioxide, divided by 100.			
0.28 = Molecular weight of nitrogen or carbon monoxide, divided by 100.			
% CO ₂ = Percent carbon dioxide by volume, dry basis.	0.1	0.1	0.1
% O ₂ = Percent oxygen by volume, dry basis.	20.8	20.8	20.8

$$MWd = (0.32 * O_2) + (0.44 * CO_2) + (0.28 * (100 - (CO_2 + O_2)))$$

$$MWd = (0.32 * 20.8) + (0.44 * 0.1) + (0.28 * (100 - (0.1 + 20.8)))$$

$$MWd = (6.66) + (0.04) + (22.15)$$

MWd =	28.85	28.85	28.85
--------------	-------	-------	-------

Tma = Source Temperature, absolute(°R)			
Tm = Average dry gas meter temperature, deg F.	68.7	74.3	54.8

$$Tma = Ts + 460$$

$$Tma = 68.67 + 460$$

Tma =	528.67	534.25	514.75
--------------	--------	--------	--------

Ps = Absolute meter pressure, inches Hg.			
13.60 = Specific gravity of mercury.			
delta H = Avg pressure drop across the orifice meter during sampling, in H ₂ O	1.05	1.04	1.01
Pb = Barometric Pressure, in Hg.	30.19	30.10	30.12

$$Pm = Pb + (\text{delta H} / 13.6)$$

$$Pm = 30.19 + (1.04883333333333 / 13.6)$$

Pm =	30.27	30.18	30.19
-------------	-------	-------	-------

Yqa = dry gas meter calibration check value, dimensionless.			
0.03 = (29.92/528)(0.75) ² (in. Hg ^{0.5} /R) cfm ² .			
29.00 = dry molecular weight of air, lb/lb-mole.			
Vm = Volume of gas sample measured by the dry gas meter at meter conditions, dcf.	52.225	52.835	51.040
Y = Dry gas meter calibration factor (based on full calibration)	1.0069	1.0069	1.0069
Delta H@ = Dry Gas meter orifice calibration coefficient, in. H ₂ O.	1.8812	1.8812	1.8812
avg SQRT Delta H = Avg SQRT press. drop across the orifice meter during sampling, in. H ₂ O	1.0172	1.0142	1.0012
O = Total sampling time, minutes.	96	96	96

$$Yqa = (O / Vm) * \text{SQRT} (0.0319 * Tma * 29) / (\text{Delta H}@ * Pm * MWd) * \text{avg SQRT Delta H}$$

$$Yqa = (96.00 / 52.23) * \text{SQRT} (0.0319 * 528.67 * 29) / (1.88 * 30.27 * 28.85) * 1.02$$

$$Yqa = 1.838 * \text{SQRT} 489.070 / 1,642.718 * 1.02$$

Yqa =	1.0203	1.0123	1.0153
--------------	--------	--------	--------

Diff = Absolute difference between Yqa and Y	1.33	0.54	0.83
--	------	------	------

$$\text{Diff} = ((Y - Yqa) / Y) * 100$$

$$\text{Diff} = ((1.0069 - 1.020) / 1.0069) * 100$$

Average Diff = 0.9

Allowable = 5.0

Y Factor Calibration Check Calculation

MODIFIED METHOD 0010 TEST TRAIN

BLOWER INTAKE

METER BOX NO. 29

2/26/2019 - 2/2/2019 & 3/1/2019

	Run 1	Run 2	Run 3
MWd = Dry molecular weight source gas, lb/lb-mole.			
0.32 = Molecular weight of oxygen, divided by 100.			
0.44 = Molecular weight of carbon dioxide, divided by 100.			
0.28 = Molecular weight of nitrogen or carbon monoxide, divided by 100.			
% CO ₂ = Percent carbon dioxide by volume, dry basis.	0.0	0.0	0.0
% O ₂ = Percent oxygen by volume, dry basis.	20.9	20.9	20.9

$$MWd = (0.32 * O_2) + (0.44 * CO_2) + (0.28 * (100 - (CO_2 + O_2)))$$

$$MWd = (0.32 * 20.9) + (0.44 * 0) + (0.28 * (100 - (0 + 20.9)))$$

$$MWd = (6.69) + (0.00) + (22.15)$$

MWd =	28.84	28.84	28.84
--------------	-------	-------	-------

Tma = Source Temperature, absolute(°R)			
Tm = Average dry gas meter temperature, deg F.	60.4	78.3	65.1

$$Tma = Ts + 460$$

$$Tma = 60.39 + 460$$

Tma =	520.39	538.26	525.13
--------------	--------	--------	--------

Ps = Absolute meter pressure, inches Hg.			
13.60 = Specific gravity of mercury.			
delta H = Avg pressure drop across the orifice meter during sampling, in H ₂ O	3.00	3.00	3.00
Pb = Barometric Pressure, in Hg.	29.29	30.20	30.22

$$Pm = Pb + (\text{delta H} / 13.6)$$

$$Pm = 29.29 + (3 / 13.6)$$

Pm =	29.51	30.42	30.44
-------------	-------	-------	-------

Yqa = dry gas meter calibration check value, dimensionless.			
0.03 = (29.92/528)(0.75) ² (in. Hg ^{0.75} /R) cfm ² .			
29.00 = dry molecular weight of air, lb/lb-mole.			
Vm = Volume of gas sample measured by the dry gas meter at meter conditions, dcf.	128.621	109.397	107.605
Y = Dry gas meter calibration factor (based on full calibration)	1.0100	1.0100	1.0100
Delta H@ = Dry Gas meter orifice calibration coefficient, in. H ₂ O.	1.9363	1.9363	1.9363
avg SQRT Delta H = Avg SQRT press. drop across the orifice meter during sampling, in. H ₂ O	1.7321	1.7321	1.7321
O = Total sampling time, minutes.	135	115	115

$$Yqa = (O / Vm) * \text{SQRT} (0.0319 * Tma * 29) / (\text{Delta H}@ * Pm * MWd) * \text{avg SQRT Delta H}$$

$$Yqa = (135.00 / 128.62) * \text{SQRT} (0.0319 * 520.39 * 29) / (1.94 * 29.51 * 28.84) * 1.73$$

$$Yqa = 1.050 * \text{SQRT} 481.414 / 1,647.695 * 1.73$$

Yqa =	0.9827	0.9858	0.9896
--------------	--------	--------	--------

Diff = Absolute difference between Yqa and Y	2.70	2.40	2.02
--	------	------	------

$$\text{Diff} = ((Y - Yqa) / Y) * 100$$

$$\text{Diff} = ((1.01 - 0.983) / 1.01) * 100$$

Average Diff = 2.37

Allowable = 5.0

APPENDIX F
LIST OF PROJECT PARTICIPANTS

The following WESTON employees participated in this project.

Paul Meeter	Senior Project Manager
Matt Winkeler	Team Member
Jack Mills	Team Member
Kyle Schweitzer	Team Member