



Geosyntec Consultants of NC, P.C.
NC License No.: C-3500 and C-295

INTERIM SEEP REMEDIATION OPERATION AND MAINTENANCE REPORT #2

Chemours Fayetteville Works

Prepared for

The Chemours Company FC, LLC
22828 NC Highway 87
Fayetteville, NC 28306

Prepared by

Geosyntec Consultants of NC, P.C.
2501 Blue Ridge Road, Suite 430
Raleigh, NC 27607

Geosyntec Project Number TR0795A

May 28, 2021



EXECUTIVE SUMMARY

This Operations and Maintenance Report #2 (O&M Report #2) has been prepared to document the operations, maintenance, and performance of the flow-through cells at Seeps A and C from March 1 through April 30, 2021. Seep A was initiated in the latter part of the reporting period (April 28, 2021). The median flow rate processed by the Seep A and C FTCs was 142 and 113 gallons per minute (gpm), respectively. As documented in the previous O&M Report #1, the FTC systems are capable of capturing total base flow under favorable hydraulic conditions, and additionally capture and treat a portion of wet weather flow as well. In total, over the two-month reporting period, the systems processed approximately 10,360,000 gallons of seep flow. Composite samples from performance monitoring indicated the average PFAS removal efficiency of the captured base flow was approximately 99.9% ^[1]; it is estimated that the FTCs prevented approximately 9.7 ^[1] pounds (lbs) of PFAS from being discharged to the Cape Fear River in the reporting period, and 17.4 ^[1] lbs of PFAS over the lifetime of the systems to date.

¹ Due to laboratory delays, analytical results for the samples collected on April 30 were not yet available for this reporting deadline. As such, statistics and removal percentages presented in this report include data for samples collected on March 19 and 31 and April 15, 2021. Once available, results for the sample collected on April 30, 2021 will be transmitted to NCDEQ via a report addendum.

TABLE OF CONTENTS

EXECUTIVE SUMMARY	1
1. Introduction.....	1
1.1 Construction and Startup of Seep A	1
2. Inspections, Operation, and Maintenance.....	2
2.1 Inspections.....	2
2.2 Duty Cycling	2
2.3 FTC Management During River Flooding.....	2
2.4 Material Changeouts.....	3
2.5 Issues Encountered and Resolutions	3
3. Data Collected	4
3.1 Pressure Transducers.....	4
3.2 Rainfall and River Stage.....	4
3.3 Operational and Treatment Performance Monitoring	4
3.3.1 Performance Monitoring	4
3.3.2 Breakthrough Monitoring.....	5
3.3.3 Water Quality Monitoring.....	5
3.3.4 Rain Event Monitoring.....	5
3.4 Deviations.....	6
3.4.1 Transducer Monitoring Deviations	6
3.4.2 Performance Monitoring and Wet Weather Sampling Deviations.....	6
4. Results.....	7
4.1 System Flowrates and Operational Periods.....	7
4.1.1 System Flowrate	7
4.1.2 Bypass Flow	8
4.2 Performance Monitoring Analytical Results	8
4.3 System Effectiveness.....	9
4.4 Wet Weather Sampling Results.....	9
4.5 River Elevation and Precipitation.....	9
4.6 Water Quality	10
4.7 GAC Usage.....	11
5. Summary.....	12
6. References.....	13

LIST OF TABLES

Table 1A	Summary of Operations and Maintenance Activities – Seep A
<i>Table 1B</i>	<i>(Reserved for Seep B)</i>
Table 1C	Summary of Operations and Maintenance Activities – Seep C
<i>Table 1D</i>	<i>(Reserved for Seep D)</i>
Table 2	Sampling Summary – Seep C
Table 3	Summary of Performance Monitoring Analytical Results – Seep C
Table 4	Summary of Wet Weather Analytical Results – Seep C
Table 5	Cape Fear River Elevation and Precipitation Statistics
Table 6	Water Quality Data – Seep C

LIST OF FIGURES

Figure 1	River Level and Seep C FTC As-Built Elevations
Figure 2A	Measured Discharge Flowrate – Seep A
<i>Figure 2B</i>	<i>(Reserved for Seep B)</i>
Figure 2C	Measured and Imputed Discharge Flowrate – Seep C
<i>Figure 2D</i>	<i>(Reserved for Seep D)</i>
Figure 3A	Influent Water Elevation – Seep A
<i>Figure 3B</i>	<i>(Reserved for Seep B)</i>
Figure 3C	Influent Water Elevation and Bypass Flow – Seep C
<i>Figure 3D</i>	<i>(Reserved for Seep D)</i>
Figure 4	Seep C Turbidity Logging and Precipitation (Mar – Apr 2021)

LIST OF APPENDICES

Appendix A	Seep A Process Flow Diagram (Drawing D-01)
Appendix B	Transducer Data Reduction
Appendix C	Laboratory Analytical Data Review Narrative

LIST OF ACRONYMS AND ABBREVIATIONS

%	percent
CO Addendum	Addendum to Consent Order Paragraph 12
DB	Discharge Basin
DO	Dissolved oxygen
ESB	Effluent Stilling Basin
FB1	Filter Bed-1
FB2	Filter Bed-2
FTC	flow-through cell
ft msl	feet mean sea level
GAC	granular activated carbon
gpm	gallons per minute
HDPE	high-density polyethylene
HFPO-DA	hexafluoropropylene oxide dimer
IC	Inlet Chamber
IP	Individual Permit
ISB	Influent Stilling Basin
lbs	pounds
mg/L	milligrams per liter
ng/L	nanograms per liter
NTU	nephelometric turbidity units
O&M	Operation and Maintenance
OM&M	operation, maintenance, and monitoring
PFAS	per- and polyfluoroalkyl substances
PFD	Process Flow Diagram
PFMOAA	perfluoro-2-methoxyacetic acid
PMPA	perfluoromethoxypropyl carboxylic acid
TB	Transfer Basin
TSS	total suspended solids
USGS	United States Geological Survey

1. INTRODUCTION

Geosyntec Consultants of NC, PC (Geosyntec) has prepared this Interim Seep Remediation Operation and Maintenance (O&M) Report #2 (“O&M Report #2”) on behalf of The Chemours Company FC, LLC (Chemours) to provide a summary report of Operations and Maintenance for the flow-through cells (FTCs) installed as the interim remediation systems at Seeps A and C at the Chemours Fayetteville Works Site (the Site). This O&M Report #2 has been prepared for the operational period of March 1 through April 30, 2021. Seep A FTC startup was initiated on April 28, 2021. The previous O&M Report #1 reported on the Seep C FTC from startup (December 16, 2020) through February 28, 2021. The next O&M Report (#3) will cover the next bimonthly period (May-June 2021) and is anticipated to include startup activities at Seeps B and D.

As the O&M Report #1 from March 31, 2021 presented FTC performance data for the first time, detailed information was provided on the hydraulic mechanics of the system, flood management practices, data collection methodology and reduction process, and flow calculation formulas. As a simplifying step for presentation clarity, at various sections in this O&M Report #2, reference is made to these details in O&M Report #1. For an overview of the hydraulic functionality of the system, see Section 1.1 of O&M Report #1.

1.1 Construction and Startup of Seep A

Substantial completion of construction was achieved at the Seep A FTC on April 28, 2021, and startup commenced thereafter. A record of construction, including as-built record drawings, will be provided in the forthcoming Seep A Interim Effectiveness Report that will be submitted to North Carolina Department of Environmental Quality by August 28, 2021. A process flow diagram for Seep A is provided in Appendix A. The process flow diagram for Seep C was provided in O&M Report #1.

As detailed in paragraph 2(vi) of the CO Addendum, the Interim Effectiveness Report is required within four months after construction. The Interim Effectiveness Report is required by the CO Addendum to include analysis of the second and third full calendar months of operation (i.e., June and July 2021) which extends beyond the reporting period of this Report (March 1, 2021 through April 30, 2021).

2. INSPECTIONS, OPERATION, AND MAINTENANCE

The following sections describe the inspections, operation, and maintenance activities completed at the Seeps A and C FTCs during the current reporting period (March 1 through April 30, 2021).

2.1 Inspections

Per the CO Addendum, routine inspections occurred on a weekly basis (at a minimum), and also occurred after 0.5 inch or greater rain events within a 24-hour period. An Inspection Form was filled out by operation, maintenance, and monitoring (OM&M) personnel during each inspection.

The routine inspections included, but were not limited to:

- documenting the system duty cycle (i.e., lead/lag orientation of the GAC filter beds)
- measuring and collecting operational parameters/data, notably water elevation data that are used to evaluate influent flowrate and the occurrence (if any) of bypass
- documenting any potential observed issues, such as sediment accumulation in the impoundment basin, structural problems, GAC fouling, and debris that is impairing flow through the system
- inspecting the autosamplers
- photographing the conditions observed, including any bypass flow

A summary of the inspection and maintenance events completed during this reporting period is provided in Tables 1A/C for Seeps A and C, respectively. Further details of these events are provided in the following subsections.

2.2 Duty Cycling

As described in Section 1.1 of the O&M Report #1, the Seep FTCs are constructed of two filter beds which operate in series. Tables 1A/C detail the filter bed configurations for Seeps A and C over the reporting period of March 1 through April 30, 2021.

2.3 FTC Management During River Flooding

As described in the Interim Seeps Remediation System Plan (Geosyntec, 2020), to treat total base flow of each seep, it was necessary to install the interim remedies within the floodway. The historical river elevations were referenced to develop the design elevations of key features such as the spillway and the top of the wall. Additionally, an action level was developed for autosampler removal to prevent damage to electronic components by flood waters. Based on a review of the historical record, a W.O. Huske Lock and Dam gage height of 10 feet (or approximately 38 ft above mean sea level) was selected as the action level for removing autosamplers. Review of historical river stage data indicated that once the river level exceeded this action level, it would typically continue to rise past the level of the FTC walls.

During this reporting period (March 1 through April 30, 2021), the Cape Fear River was only above the action level in the beginning of March (from March 1 through 8), from flooding in late February that was receding. In April, the action level was not triggered. Impacts to the composite sampling collection periods are discussed in Section 3.4.2. More details regarding the Cape Fear River flooding are also described in Section 4.5.

2.4 Material Changeouts

As discussed in the Interim Seeps Remediation System Plan (Geosyntec, 2020), when breakthrough monitoring sampling indicates the concentration of PFAS in the midpoint of the system has reached 30% of the concentration of PFAS in the influent, a GAC changeout will be scheduled.

The frequency and severity of flooding and rain events in February is believed to be the primary cause of Seep C lead bed clogging (FB2) in late March. Although PFAS breakthrough was not observed, this bed was changed out on March 26, 2021 as a precaution.

2.5 Issues Encountered and Resolutions

Shortly after the Seep C System commenced operation, observations from routine inspections noted fine-grained sediment accumulating on the surface of the filter beds, especially in the lead filter bed. Prior to construction of the FTC, the turbidity of Seep C was on average approximately 28 nephelometric turbidity units (NTU) (Geosyntec, 2020); following startup of the system, turbidity was on average 137 NTU up to a maximum recorded value of 356 NTU (Geosyntec, 2021). As documented in O&M Report #1, sediment management techniques were developed and refined, and included scrubbing and vacuuming the geocomposite layer above the GAC, and periodic replacement of both the geocomposite and the top few inches of GAC underneath the geocomposite. In addition, since O&M Report #1, the following steps have been implemented:

- Installation of a turbidity curtain in the upstream impoundment to reduce the turbidity of water entering the FTC.
- Addition of an approximate 3-inch layer of 20/40 filter sand on top of the stone layer in the Inlet Chamber (IC) to reduce sediment loading into the filter beds.
- Installation of 10-micron filter bags on the inlet pipes into the lead filter bed.

3. DATA COLLECTED

The FTC includes design components to measure water levels in the system, precipitation, water quality, and PFAS removal performance. The W.O. Huske Lock and Dam gage station is also used to reference nearby precipitation and river levels.

3.1 Pressure Transducers

The Influent Chamber (IC) and Effluent Stilling Basin (ESB) are each equipped with a stilling well in which a non-vented Levellogger® is installed below the operational water level. The water levels acquired from processing the transducer data are used to estimate flows the system processes, and to record the occurrence of flow that is diverted past the system via the Bypass Spillway. Section 4.1 of the O&M Report #1 describes the process used to calculate the flowrates through the FTC based on the water levels.

The pressure transducer data were downloaded regularly as part of routine inspections (weekly at a minimum). Additionally, manual water level measurements were collected in the basins and stilling wells whenever transducers were downloaded to equilibrate the transducer readings (discussed in Section 4.1).

3.2 Rainfall and River Stage

Precipitation and river stage are monitored by using the United States Geological Survey (USGS) weather monitoring station at the W.O. Huske Dam (gage 02105500). This station is approximately 1,200 feet from Seep C and records precipitation and river elevation data every 15 minutes.

3.3 Operational and Treatment Performance Monitoring

Operational and performance monitoring of the system includes the composite collection of water samples from various locations in the system, and direct measurement of water quality parameters. The operational and performance monitoring is completed on a regular basis to evaluate:

- PFAS removal efficiency (i.e. performance monitoring)
- breakthrough of PFAS compounds between GAC filter beds, using grab samples on an as-needed basis (i.e. breakthrough monitoring)
- water quality parameters specified in the CO Addendum
- potential effects of 0.5-inch rain events on PFAS concentrations (i.e. wet weather monitoring)

3.3.1 Performance Monitoring

Composite samples for performance monitoring are collected using portable, battery-powered autosamplers (e.g. Teledyne ISCO 6712 Full-Size Portable Sampler). At the end of the sampling period, the OM&M personnel fill laboratory-supplied sample containers from the common

container within the autosampler. Sampling is conducted in accordance with the PFAS Quality Assurance Project Plan (AECOM, 2018). Any adjustments made to address potential deficiencies (e.g. low battery power, river flooding) are documented on the Inspection Form.

Four performance monitoring samples for Seep C – a minimum of twice per calendar month per CO Addendum Paragraph 2(a)(iii) - were collected during this reporting period (Table 2). Samples were stored on wet ice in a cooler until shipment to an external laboratory (Eurofins TestAmerica Laboratories Sacramento or Lancaster). Chain-of-custody documents were completed and included with each shipment. Performance monitoring samples were analyzed for Table 3+ PFAS, as outlined in the *Interim Seep Remediation System Plan* (Geosyntec, 2020).

Seep A samples were not collected during the reporting period. Performance and wet weather monitoring will begin in May 2021 and will be included in the O&M Report #3.

3.3.2 Breakthrough Monitoring

Grab samples were collected from the IC, TB, and ESB at Seep C for evaluation of system performance and the need for GAC changeouts. A total of 7 breakthrough monitoring samples were collected for Seep C during this reporting period.

3.3.3 Water Quality Monitoring

The water quality in the IC and ESB at Seep C was monitored at the same minimum frequency as performance monitoring described above – at least twice per month. Dissolved oxygen (DO), pH, turbidity, specific conductivity, temperature, and total suspended solids (TSS) were measured using a calibrated In-Situ Aqua TROLL 500 multiparameter sonde.

3.3.4 Rain Event Monitoring

Wet weather samples were collected at a frequency of once per calendar month following a rain event of at least 0.5 inches within a 24-hour period. Composite samples for wet weather monitoring are collected using Teledyne ISCO 6712 Full-Size Portable Samplers (the same make and model as performance monitoring discussed above, but a dedicated set for wet weather sampling only). The wet weather autosamplers are equipped with Teledyne 674 rain gauges that measure rainfall depth. When rainfall exceeds 0.5 inches in a 24-hour period, the rain gauge sends a signal to the Teledyne 6712 to begin a sampling cycle, where the autosampler collects aliquots every hour for 24 hours. OM&M personnel fill sample containers and follow the same sample collection protocols for wet weather as described in Section 3.3.1 above.

Wet weather monitoring samples were analyzed for Table 3+ PFAS, as outlined in the *Interim Seep Remediation System Plan* (Geosyntec, 2020). Table 2 lists the wet weather sample collected at Seep C during the reporting period and the associated cumulative rainfall prior to the sampling timeframe.

3.4 Deviations

Deviations for each of the data types collected are described below.

3.4.1 Transducer Monitoring Deviations

There were no deviations in the download or analysis of transducer data during this reporting period.

3.4.2 Performance Monitoring and Wet Weather Sampling Deviations

There were no deviations in the planned number of collected performance monitoring samples during this reporting period. The required performance monitoring and wet weather samples were collected, noting that wet weather samples were not collected in April, as there was not a qualifying rain event to trigger collection.

Autosamplers were removed from the FTC following the river flooding action level procedure (Section 2.3) in February 2021, resulting in a composite period for the first performance sample in March beginning on March 5, 2021. On one occasion, a composite sample accrued fewer than the planned 336 hours (14-day) of aliquot collection, due to a composite period of fewer than 14 days (SEEP-C-INFLUENT-330-033121 and SEEP-C-EFFLUENT-330-033121). Actual collected composite periods ranged from 330-336 hours during this reporting period; dates of composite periods for each sample are listed in Table 2.

4. RESULTS

The results for each type of data collected are described in detail in the following subsections. A brief overview of the results is as follows:

Reporting Period Metric	Seep A	Seep C	Total
Duration	61 days (March 1 - April 30, 2021)		
Rainfall, Actual (in)	3.12 (March 1 - April 30, 2021)		
Rainfall, Historical Average (in)	5.92 (March 1 - April 30, 2004-2020)		
River Above Spillway (days)	0	0.5	N/A
Operational Period (days)	3	60.5	N/A
Median Flow Rate (gpm)	142	113	N/A
Seep Volume Treated (gallons)	460,000	9,900,000	10,360,000
PFAS Removed (lbs)	N/A*	9.7 ^[2]	9.7 ^[2]
GAC Replaced (lbs)	0	9,000	9,000

* Seep A samples were not collected during the reporting period. Performance and wet weather monitoring will begin in May 2021 and will be included in the O&M Report #3.

4.1 System Flowrates and Operational Periods

4.1.1 System Flowrate

A detailed discussion of pressure transducer water level measurements in the Effluent Stilling Basin, and the data reduction process to convert these levels to flow rates, is provided in Sections 3.1, 3.4.1, and 4.1.1 of O&M Report #1. This data reduction process, updated for the current reporting period of March through April 2021, is provided in Appendix B.

Figures 2A/C shows the measurable flowrates through the FTC over the reporting period for Seeps A and C, respectively. Seep A water elevations and flowrates were calculated using design elevations. A licensed survey of the key features will be performed in June 2021 and the calculations for future reports will be updated with as-built elevations. At Seep C, for instances where the system was known to be processing base flow, but transducer data were not available, flowrate was imputed. The extrapolation from January 29 through March 9, 2021 (i.e., the date of Weir 3 installation completion), utilized the median flowrate from the entire dataset of measurable flowrates prior to January 27, 2021.

² Due to laboratory delays, analytical results for the sample collected on April 30 were not yet available for this reporting deadline. As such, statistics and removal percentages presented in this report include data for samples collected on March 19 and 31 and April 15, 2021. Once available, results for the sample collected on April 30, 2021 will be transmitted to NCDEQ via a report addendum.

The median of the measured flowrate through the Seep C FTC during the current reporting period was 113 gallons per minute (gpm), and the calculated 95th percentile value was 172 gpm. The design basis of 76 gpm (Geosyntec, 2020) was selected as the 95th percentile value of dry weather base flow from flume pre-design data.

As there were only 3 operational days for Seep A during this reporting period, flowrate statistics were not calculated. A detailed flowrate analysis will be discussed in the subsequent O&M Report #3.

Using the measured and extrapolated flowrate calculations, approximately 460,000 and 9,900,000 gallons of water (10,360,000 gallons total) were treated by the Seeps A and C FTCs, respectively, from March 1 through April 30, 2021.

4.1.2 Bypass Flow

A detailed discussion of pressure transducer water level measurements in the FTC Influent Stilling Basin (ISB), and the data reduction process to convert these levels to the elevation of the bypass spillway, is provided in Section 3.1, 3.4.1, and 4.1.2 of O&M Report #1. This data reduction process, updated for the current reporting period of March through April 2021, is provided in Appendix B.

The following sections describe conditions at Seep C. As there were only 3 days of startup operation at Seep A, with no bypass observed as shown in Figure 3A (and only a gradual increase in the impoundment elevation), a detailed analysis for Seep A will be discussed in the subsequent O&M Report #3.

The resulting figure for influent water level elevation and occurrences of bypass flow is provided in Figure 3C. As shown, bypass flow was observed at Seep C in several periods in March and April 2021.

In March, approximately 2.07 inches of rain fell, similar in magnitude to the historical average of 2.79 inches. In April, approximately 1.05 inches of rain fell, much less than the historical average of 3.13 inches. Overall, the total rainfall in the reporting period (3.12 inches) was approximately 47% less than average (5.92 inches).

Correspondingly, bypass flow at Seep C in March and April was significantly less frequent than in January and February (O&M Report #1) due to less rainfall and continuous improvement measures being implemented as outlined in the preventative maintenance procedures employed at the FTC. Notably, several wet weather events in March and April were fully captured and treated by the Seep C FTC.

4.2 Performance Monitoring Analytical Results

Analytical results for the four composite performance monitoring samples are provided in Table 3 and described below. Laboratory analytical results are compiled in Appendix C. The sampling results discussed here pertain to Seep C, as no samples were collected at Seep A during the current

reporting period. Total Table 3+ PFAS compounds (17 compounds) in the influent ranged from 146,300 to 151,830 nanograms per liter (ng/L). The average and median total Table 3+ (17 compounds) concentrations were approximately 148,916 ng/L and 148,617 ng/L, respectively. Within each influent sample, the constituents of highest concentration were HFPO DA, PFMOAA, and PFO2HxA.

Total Table 3+ PFAS compounds (17 compounds) in the effluent ranged from 57 to 207 ng/L, representing a removal efficiency range of 99.9 to 100.0% in the four composite samples.

4.3 System Effectiveness

System effectiveness, defined by the percentage removal of the combined concentrations of the three indicator parameters (HFPO-DA, PFMOAA and PMPA), is determined on a monthly average basis for the system using volume weighted concentrations of the influent and effluent samples. Volume weighted concentrations were developed in the event that either the influent and effluent autosamplers have different compositing durations or that the two composite sampling periods in the month have different durations (e.g. 14 days and 10 days). Both circumstances could arise due to a potential equipment malfunction or severe weather event. Weighting by volume provides a representative assessment of mass present in both the influent and effluent over time; samples corresponding to greater flow volumes will have a proportionately higher weight. System effectiveness is calculated using the equation presented in Section 4.3 of the O&M Report #1. The system effectiveness results discussed here pertain to Seep C, as no samples were collected at Seep A during the current reporting period.

Based on the system flowrate data (Section 4.1.1) and the performance monitoring composite sample data of the three indicator compounds (Section 4.2), the system effectiveness was calculated to be 99.9%. This value is similar to the Table 3+ removal efficiency described in Section 4.2 which is due to the fact that the removal efficiency was mostly steady throughout the reporting period, and that the influent and effluent composite periods were nearly identical.

4.4 Wet Weather Sampling Results

A single wet weather monitoring sample was collected at Seep C during the reporting period (Table 2), and its analytical results are shown in Table 4. Laboratory analytical results are compiled in Appendix C. The removal efficiency of the Total Table 3+ compounds (17 compounds) was 99.9%. As noted in Paragraph 2(a)(iii) in the CO Addendum, these results are not to be used to determine compliance under Paragraph 2(a)(vi). No wet weather monitoring samples were collected at Seep A during this reporting period.

4.5 River Elevation and Precipitation

The Cape Fear River was monitored using the existing USGS weather monitoring station at the W.O. Huske Dam (gage 02105500), as described in Section 3.2.

Three key river elevations, in reference to the FTC at Seep C, were monitored for their effect on system performance:

- (i) When the river rises above the top of the GAC at 38.85 feet mean sea level (ft msl), head differentials throughout the FTC are reduced and flow through the system is hindered.
- (ii) When the river rises above the invert of the Bypass Spillway at 41.28 ft msl, the influent and effluent water elevation are equal and flow through the system ceases.
- (iii) When the river rises above the top of the FTC walls at 42.35 ft msl, maintenance is required to repair any damages from flooding.

A statistical summary of the Cape Fear River elevation relative to these key elevations is provided in Table 5. The elevation of the Cape Fear River was above the GAC on one occasion during the reporting period, for a total of 5.5 days, and above the Bypass Spillway on one occasion during the reporting period, for a total of 0.5 days. The river did not rise above the elevation of the FTC walls and inundate the FTC during the current reporting period. The changes in elevation of the Cape Fear River are shown in Figure 1.

The Cape Fear River was above the elevation of the Bypass Spillway 1% of the reporting period, which is less than the historical annual average of 2.2%. Finally, the Cape Fear River was above the elevation of the GAC 9% of the reporting period, as compared to a historical annual average of 3.7%. In 2021, a cumulative rainfall of 14.95 inches year-to-date has been recorded. Comparatively, from 2004-2020, the historical average rainfall from January through April was 11.09 inches.

4.6 Water Quality

The water quality measurements collected during reporting period are provided in Table 6 and described below. As water quality parameters were not measured at Seep A during the current reporting period, the parameters described here pertain to Seep C only:

- **DO:** There appeared to be a modest effect on DO during the reporting period, with a 35% median decrease from the influent to the effluent. The system does not use biological activity to treat influent water, therefore, DO is not expected to decrease significantly over the system's residence time. DO will continue to be monitored to evaluate potential effects of biological activity as the operational period extends from spring to summer.
- **Temperature:** There was limited effect on temperature of the water as a result of flow through the FTC, with a 1% median increase from the influent to the effluent. Due to the relatively short residence time in the FTC, temperature is not expected to change significantly throughout the FTC.

- **Specific Conductance:** Similar to the above parameters, there appeared to be only a minor effect on conductivity, with a median increase of 18%. The FTC is expected to have little effect on the anion/cation content of the seep baseflow.
- **pH:** From the IC to the ESB, the pH of treated water increased during every monitoring event, with a median increase of 1.08 Standard Units. This effect was anticipated and is likely a result of the inflow's contact with the concrete walls of the FTC and the GAC in the filter beds.
- **Turbidity and TSS:** During the drier months of March and April 2021, turbidity of the influent water entering the FTC was on average 31 NTU, which is similar to pre-construction conditions, and significantly less than January and February. The reduction of turbidity entering the FTC in the months of March and April is likely a result of (1) decreased rainfall, (2) establishment of vegetation growth in disturbed areas within the Seep catchments, and (3) improved sediment control techniques like the turbidity curtains installed within the impoundments. Figure 4 presents the relationship observed between precipitation and turbidity.

The FTC significantly decreased the turbidity of the water from the influent to the effluent during nearly every field monitoring event, with the exception of April 27 and April 30, 2021. On a median basis, the FTC decreased turbidity by 93% during the reporting period. Turbidity is expected to decrease as water passes through the FTC chambers, including the roughing filter, sand layer in the inlet chamber, filter bags on the inlet valves, and the two GAC filter beds. The increase in turbidity on April 27 and 30 are likely a result of an accumulation of fine silts on the lag filter bed. The surface of FB2 bed was subsequently cleaned and is expected to return to normal turbidity conditions in the next reporting period.

At field events from March 1 through April 27, 2021, TSS was observed to be 0.0 mg/L in both the influent and effluent monitoring locations.

4.7 GAC Usage

On March 26, 9,000 lbs of GAC was replaced in FB2. No GAC was replaced at Seep A during the reporting period.

5. SUMMARY

The following summarizes the FTC's performance after the completion of the latest reporting period (March 1 through April 30, 2021):

- Generally, the conclusions reached from the first few months of operation, as documented in O&M Report #1, have not changed. Flow data from Seep C indicates the system is capable of treating approximately double the design basis flow rate under favorable hydraulic conditions. Wet weather flow is frequently captured, in some cases fully captured, and treated equally to dry weather flows when captured. Performance monitoring results indicate the PFAS removal efficiency of captured baseflow is approximately 99.9%. To date, the Seep C FTC has prevented approximately 17.4 lbs of PFAS from being discharged to the Cape Fear River. PFAS removal calculations for Seep A will be evaluated in O&M Report #3 when performance monitoring samples are collected.
- The initial reporting period (startup through February 28, 2021) included extraordinarily high amounts of rainfall which resulted in high levels of baseflow and loading of fine-grained sediment. Sediment management techniques were continuously developed and improved, including most recently the installation of turbidity curtains, a sand filtration layer in the inlet chamber, and 10-micron filter bags on the inlet pipes into the lead filter bed. These measures, coupled with reduced precipitation in March and April 2021, have significantly improved the capture of dry and wet weather baseflow.

The next reporting period (May 1 through June 30, 2021) will be detailed in O&M Report #3 Report, to be submitted no later than July 31, 2021. Additionally, the overall scope of O&M activities will continue to be evaluated, and a modification may potentially be proposed after six months of operation at all four systems, as permitted under Paragraph 2(a)(iv).

6. REFERENCES

AECOM, 2018. Poly and Perfluoroalkyl Substance Quality Assurance Project Plan. August 2018.

Geosyntec, 2020. Interim Seep Remediation System Plan. Chemours Fayetteville Works. 31 August 2020.

Geosyntec, 2021. Interim Seep Remediation Operation and Maintenance Report #1. Chemours Fayetteville Works. 31 March 2020.

TABLES

Table 1A
Summary of Operations and Maintenance Activities - Seep A
Reporting Period 2 (Mar - Apr 2021)
 Chemours Fayetteville Works
 Fayetteville, North Carolina

Reporting Period	Date	Days Since Startup	Bypass Spillway Flow?	Sampling Performed			Operational Mode				Transducers Downloaded	Maintenance Activities Completed	Notes
				Breakthrough Monitoring	Performance Monitoring	Wet Weather Monitoring	Arrival		Departure				
							FB1	FB2	FB1	FB2			
Month 1	04/28/2021	0	No				Lead	Lag	Lead	Lag		N/A	Seep A System startup.
	04/30/2021	2	No				Lead	Lag	Lead	Lag		N/A	

Table 1C
Summary of Operations and Maintenance Activities - Seep C
Reporting Period 2 (Mar - Apr 2021)
Chemours Fayetteville Works
Fayetteville, North Carolina

Reporting Period	Date	Days Since Startup	Bypass Spillway Flow?	Sampling Performed			Operational Mode				Transducers Downloaded	Maintenance Activities Completed	Notes
				Breakthrough Monitoring	Performance Monitoring	Wet Weather Monitoring	Arrival		Departure				
							FB1	FB2	FB1	FB2			
Month 3	03/01/2021	76	Yes				Lag	Lead	Lag	Lead	X	Weirs W2 and W3 were tightened.	
	03/04/2021	79	Yes				Lag	Lead	Lag	Lead		Vacuum lead filter bed.	
	03/09/2021	84	Yes	X			Lag	Lead	Lead	Closed	X	Weir 3 was tightened. Low spot on NE corner of pad excavated and filled with concrete. Filter bed two vacuumed.	V22 and V21 are both open. FB2 is isolated from all inputs. FB1 is now lead and only FB2 can discharge into midbasin. Left this way in an attempt to identify clog point.
	03/11/2021	86	No				Lead	Closed	Lag	Lead		Cleaned FB2 GAC layer. Approximately 1.5 inches removed and new fabric installed over top.	
	03/16/2021	91	No	X			Lag	Lead	Lag	Lead	X	Vacuumed until transfer pump clogged with metal debris and mulch, then stiff brushed.	
	03/17/2021	92	Yes			X	Lag	Lead	Lag	Lead		Stiff brushed sediment layer on FB2.	
	03/18/2021	93	Yes				Lag	Lead	Lag	Lead		Removed sediment layer on top of geotextile fabric. First used pond vacuum then stiff brush to break up sediment layer. Secured ISCOs to grates with ratchet straps.	
	03/19/2021	94	Yes		X		Lag	Lead	Lead	Changeout		Valves from FB2 to midpoint opened, valve from FB2 exhaust to midpoint closed. FB2 is being bypassed, all water is being sent to FB1 for processing.	
	03/22/2021	97	Yes				Lead	Changeout	Lead	Changeout		Vacuumed FB1. Flush sediment-laden water through silt bag onsite.	
	03/23/2021	98	Yes	X			Lead	Changeout	Lead	Changeout	X	Replaced FB1 fabric and removed approximately 1.5 inches of GAC.	
	03/26/2021	101	No				Lead	Changeout	Lead	Lag		GAC changeout in FB2 due to head loss.	
03/30/2021	105	No		X		Lead	Lag	Lead	Lag	X	Hard scrub and flush to break up sediment and flush out cell. Input from influent basin and input from midpoint transfer basin left open. Water in midpoint was pumped upstream above silt fence.	FB1 shows a headloss and water in the impoundment is breaking the lip of the spillway. Summit requests to dewater the midpoint for access to fix V1 handle.	

Table 1C
Summary of Operations and Maintenance Activities - Seep C
Reporting Period 2 (Mar - Apr 2021)
 Chemours Fayetteville Works
 Fayetteville, North Carolina

Reporting Period	Date	Days Since Startup	Bypass Spillway Flow?	Sampling Performed			Operational Mode				Transducers Downloaded	Maintenance Activities Completed	Notes
				Breakthrough Monitoring	Performance Monitoring	Wet Weather Monitoring	Arrival		Departure				
							FB1	FB2	FB1	FB2			
Month 4	04/01/2021	107	Yes		X		Lead	Lag	Lead	Lag		N/A	FB1 has a head difference greater than 24 inches.
	04/02/2021	108	Yes				Lead	Lag	Lead	Lag		Turbidity curtain installed. Vacuumed FB1.	Autosampler program ended early after 4 aliquots. Program started at 4-1-21 at 14:00 and ended at 4-2-21 at 08:00. Noticed at 14:15 on 4-2-21. Reprogrammed and restarted to start at 14:20 on 4-2-2021 to run continuously.
	04/05/2021	111	Yes				Lead	Lag	Lead	Lag	X	Vacuumed FB1 and inlet basin fabric.	
	04/07/2021	113	Yes				Lead	Lag	Lead	Lag		Approximately 1 inch GAC removed from FB1. New fabric installed in FB1.	
	04/12/2021	118	No	X			Lead	Lag	Lead	Lag	X	Vacuumed FB1 and FB2 as proactive maintenance.	
	04/15/2021	121	No		X		Lead	Lag	Lead	Lag		Removed one layer of sand and filter fabric from IB and added clean sand in IB.	
	04/19/2021	125	Yes	X			Lead	Lag	Closed	Lead	X	N/A	
	04/20/2021	126	No				Closed	Lead	Lead	Lag		Removed filter fabric and approximately 1 inch of GAC from FB1. Replaced with new fabric.	Visually appeared to be less sediment on fabric than previously observed.
	04/27/2021	133	No	X			Lead	Lag	Lead	Lag	X	Filter socks added to inlets. Preventative vacuuming on FB2.	
	04/28/2021	134	No				Lead	Lag	Lead	Lag		10-micron silt bag filters were installed on the intake valves for FB-1. FB-1 and FB-2 were vacuumed.	
	04/29/2021	135	No				Lead	Lag	Lead	Lag		N/A	Appears to be silt on fabric for FB2. Potentially algae growth.
04/30/2021	136	No		X		Lead	Lag	Lead	Lag		Change fabric at FB2 and rake GAC smooth.		

Table 2
Sampling Summary - Seep C
Reporting Period 2 (Mar - Apr 2021)
 Chemours Fayetteville Works
 Fayetteville, North Carolina

Performance Monitoring Composite Samples

Sample ID	Composite Period	Sample Date
SEEP-C-INFLUENT-336-031921 SEEP-C-EFFLUENT-336-031921	March 5-19, 2021 ^[1]	March 19, 2021
SEEP-C-INFLUENT-300-033121 SEEP-C-EFFLUENT-300-033121	March 19-31, 2021	March 31, 2021
SEEP-C-INFLUENT-336-041521 SEEP-C-EFFLUENT-336-041521	April 2-15, 2021	April 15, 2021
SEEP-C-INFLUENT-336-043021 SEEP-C-EFFLUENT-336-043021	April 15-30, 2021	April 30, 2021

Wet Weather Composite Sample

Sample ID	Sample Date	Sample Time	Cumulative Rainfall (inches)
SEEP-C-RAIN-INFLUENT-24-031721 SEEP-C-RAIN-EFFLUENT-24-031721	March 17, 2021	11:42	0.91

Notes

- 1 Discontinuities in sample composite period due to removal of autosamplers during river flooding events.
- 2 Sample Identification Label Key: "Seep - [A, B, C, or D] - [Sample Location Inside FTC] - [# of Aliquots in Composite Sample] - [MMDDYY]"
- 3 No wet weather samples were collected in April, as there was no qualifying rain event to trigger sample collection.

Table 3
Summary of Performance Monitoring Analytical Results - Seep C
Reporting Period 2 (Mar - Apr 2021)
 Chemours Fayetteville Works
 Fayetteville, NC

<i>Table 3+ SOP (ng/L)</i>	SEEP-C- INFLUENT-336- 031921 Sample Date: 19-Mar-21	SEEP-C- EFFLUENT-336- 031921 Sample Date: 19-Mar-21	Percent Removal	SEEP-C- INFLUENT-300- 033121 Sample Date: 31-Mar-21	SEEP-C- EFFLUENT-300- 033121 Sample Date: 31-Mar-21	Percent Removal	SEEP-C- INFLUENT-336- 041521 Sample Date: 15-Apr-21	SEEP-C- EFFLUENT-336- 041521 Sample Date: 15-Apr-21	Percent Removal
Hfpo Dimer Acid	18,000	11	99.9%	16,000	7.3	100.0%	19,000	4.6	100.0%
PFMOAA	79,000	150	99.8%	83,000	94	99.9%	81,000	48 J	99.9%
PFO2HxA	24,000	18	99.9%	26,000	9.2 J	100.0%	24,000	4.8	100.0%
PFO3OA	7,100	4.9	99.9%	8,100	3	100.0%	8,000	<2.0	100.0%
PFO4DA	3,400	<2.0	100.0%	2,500	<2.0	100.0%	2,600	<2.0	100.0%
PFO5DA	74	<2.0	100.0%	<78	<2.0	100.0%	<78	<2.0	100.0%
PMPA	8,700	18	99.8%	10,000	15	99.9%	8,300	<10	100.0%
PEPA	3,500	<20	100.0%	3,700	<20	100.0%	3,300	<20	100.0%
PS Acid	<9.8	<2.0	100.0%	<20	<2.0	100.0%	<20	<2.0	100.0%
Hydro-PS Acid	430	<2.0	100.0%	440	<2.0	100.0%	440	<2.0	100.0%
R-PSDA	660	5	99.2%	870	<2.0	100.0%	750	<2.0	100.0%
Hydrolyzed PSDA	800	<2.0	100.0%	1,100	<2.0	100.0%	670	<2.0	100.0%
R-PSDCA	16	<2.0	100.0%	<17	<2.0	100.0%	17	<2.0	100.0%
NVHOS, Acid Form	780	<2.0	100.0%	890	<2.0	100.0%	760	<2.0	100.0%
EVE Acid	<8.7	<2.0	100.0%	<17	<2.0	100.0%	<17	<2.0	100.0%
Hydro-EVE Acid	1,300	<2.0	100.0%	1,200	<2.0	100.0%	1,200	<2.0	100.0%
R-EVE	740	<2.0	100.0%	890	<2.0	100.0%	710	<2.0	100.0%
PES	<3.4	<2.0	100.0%	<6.7	<2.0	100.0%	<6.7	<2.0	100.0%
PFECA B	<13	<2.0	100.0%	<27	<2.0	100.0%	<27	<2.0	100.0%
PFECA-G	<24	<2.0	100.0%	<48	<2.0	100.0%	<48 UJ	<2.0 UJ	100.0%
Total Table 3+ (17 Compounds)^[1,2]	150,000	200	99.9%	150,000	130	99.9%	150,000	57	100.0%
Total Table 3+ (20 Compounds)^[1]	150,000	210	99.9%	150,000	130	99.9%	150,000	57	100.0%

Notes:

1 - The total Table 3+ sum is rounded to two significant figures.
 2 - The three Table 3+ compounds that are not included in the list of 17, but are included in the list of 20, are R-PSDA, R-EVE, and Hydrolyzed PSDA.

Bold - Analyte detected above associated reporting limit

EPA - Environmental Protection Agency

J - Analyte detected. Reported value may not be accurate or precise

ng/L - nanograms per liter

QA/QC - Quality assurance/ quality control

SOP - standard operating procedure

UJ - Analyte not detected. Reporting limit may not be accurate or precise.

-- - Due to laboratory delays, sample analytical results were not yet available for this reporting deadline. Once available, these results will be transmitted to NCDEQ via a report addendum.

< - Analyte not detected above associated reporting limit.

Sample Identification Label Key: "Seep - [A, B, C, or D] - [Sample Location Inside FTC] - [# of Aliquots in Composite Sample] - [MMDDYY]"

Table 3
Summary of Performance Monitoring Analytical Results - Seep C
Reporting Period 2 (Mar - Apr 2021)
 Chemours Fayetteville Works
 Fayetteville, NC

<i>Table 3+ SOP (ng/L)</i>	SEEP-C- INFLUENT-336- 043021 Sample Date: 30-Apr-21	SEEP-C- EFFLUENT-336- 043021 Sample Date: 30-Apr-21	Percent Removal
Hfpo Dimer Acid	--	--	--
PFMOAA	--	--	--
PFO2HxA	--	--	--
PFO3OA	--	--	--
PFO4DA	--	--	--
PFO5DA	--	--	--
PMPA	--	--	--
PEPA	--	--	--
PS Acid	--	--	--
Hydro-PS Acid	--	--	--
R-PSDA	--	--	--
Hydrolyzed PSDA	--	--	--
R-PSDCA	--	--	--
NVHOS, Acid Form	--	--	--
EVE Acid	--	--	--
Hydro-EVE Acid	--	--	--
R-EVE	--	--	--
PES	--	--	--
PFECA B	--	--	--
PFECA-G	--	--	--
Total Table 3+ (17 Compounds)^[1,2]	--	--	--
Total Table 3+ (20 Compounds)^[1]	--	--	--

Notes:

1 - The total Table 3+ sum is rounded to two significant figures.
 2 - The three Table 3+ compounds that are not included in the list of 17, but are included in the list of 20, are R-PSDA, R-EVE, and Hydrolyzed PSDA.

Bold - Analyte detected above associated reporting limit

EPA - Environmental Protection Agency

J - Analyte detected. Reported value may not be accurate or precise

ng/L - nanograms per liter

QA/QC - Quality assurance/ quality control

SOP - standard operating procedure

UJ - Analyte not detected. Reporting limit may not be accurate or precise.

-- - Due to laboratory delays, sample analytical results were not yet available for this reporting deadline. Once available, these results will be transmitted to NCDEQ via a report addendum.

< - Analyte not detected above associated reporting limit.

Sample Identification Label Key: "Seep - [A, B, C, or D] - [Sample Location Inside FTC] - [# of Aliquots in Composite Sample] - [MMDDYY]"

Table 4
Summary of Wet Weather Analytical Results - Seep C
Reporting Period 2 (Mar - Apr 2021)
 Chemours Fayetteville Works
 Fayetteville, NC

<i>Table 3+ SOP (ng/L)</i>	SEEP-C-RAIN- INFLUENT-24- 031721 Sample Date: 03/17/2021	SEEP-C-RAIN- EFFLUENT-24- 031721 Sample Date: 03/17/2021	Percent Removal
Hfpo Dimer Acid	16,000	3.5	100.0%
PFMOAA	80,000	54	99.9%
PFO2HxA	24,000	3.3	100.0%
PFO3OA	6,200	<2.0	100%
PFO4DA	2,300	<2.0	100%
PFO5DA	88	<2.0	100%
PMPA	8,500	11	99.9%
PEPA	3,400	<20	100%
PS Acid	<9.8	<2.0	100%
Hydro-PS Acid	460	<2.0	100%
R-PSDA	600	<2.0	100%
Hydrolyzed PSDA	760	<2.0	100%
R-PSDCA	17	<2.0	100%
NVHOS, Acid Form	740	<2.0	100%
EVE Acid	<8.7	<2.0	100%
Hydro-EVE Acid	1,200	<2.0	100%
R-EVE	690	<2.0	100%
PES	<3.4	<2.0	100%
PFECA B	<13	<2.0	100%
PFECA-G	<24	<2.0	100%
Total table 3+ (17 Compounds)^{1,2}	140,000	72	99.9%
Total table 3+ (20 Compounds)²	140,000	72	99.9%

Notes:

- 1 - The total Table 3+ sum is rounded to two significant figures.
 - 2 - The three Table 3+ compounds that are not included in the list of 17, but are included in the list of 20, are R-PSDA, R-EVE, and Hydrolyzed PSDA.
 - Bold** - Analyte detected above associated reporting limit
 - EPA - Environmental Protection Agency
 - J - Analyte detected. Reported value may not be accurate or precise
 - ng/L - nanograms per liter
 - QA/QC - Quality assurance/ quality control
 - SOP - standard operating procedure
 - UJ - Analyte not detected. Reporting limit may not be accurate or precise.
 - - No data reported
 - < - Analyte not detected above associated reporting limit.
- Sample Identification Label Key: "Seep - [A, B, C, or D] - [Sample Location Inside FTC] - [# of Aliquots in Composite Sample] - [MMDDYY]"

Table 5
Cape Fear River Elevation and Local Precipitation Statistics
Reporting Period 2 (Mar - Apr 2021)
 Chemours Fayetteville Works
 Fayetteville, NC

Seep	# of Days of Operation on Record	# of Days in Reporting Period	River Above Wall Elevation		River Above Spillway Elevation		River Above GAC Elevation		River Above Discharge Pipe	
			Percent of Reporting Period	Number of Days	Percent of Reporting Period	Number of Days	Percent of Reporting Period	Number of Days	Percent of Reporting Period	Number of Days
C	136	61	0%	0.0	1%	0.5	9%	5.5	27%	16.5
A *	3	3	0%	0.0	0%	0.0	0%	0.0	0%	0.0
B	0	0	TBD	TBD	TBD	TBD	TBD	TBD	TBD	TBD
D	0	0	TBD	TBD	TBD	TBD	TBD	TBD	TBD	TBD
Historical Annual Average (2007-2020)			1.7%		2.2%		3.7%		9.6%	

Precipitation (inches)	
Current Reporting Period (Mar - Apr 2021)	3.12
Current Reporting Period Historical Average (Mar - Apr 2004-2020)	5.92
2021 Year-to-Date	14.95
Historical Year-to-Date Average (2004-2020)	11.09
Historical Annual Average (2004-2020)	43.44

Notes

- 1 River elevation and precipitation data from USGS Huske Lock and Dam site 02105500.
- * Statistics for Seep A have been calculated based on design elevations and will be updated pending results of as-built survey.
- TBD To Be Determined

Table 6
Seep C Water Quality Data
Reporting Period 2 (Mar - Apr 2021)
 Chemours Fayetteville Works
 Fayetteville, North Carolina

Report Period	Date	DO			pH			Specific Conductance			Temperature			Turbidity			TSS			
		Influent	Effluent	Percent Difference	Influent	Effluent	Percent Difference	Influent	Effluent	Percent Difference	Influent	Effluent	Percent Difference	Influent	Effluent	Percent Difference	Influent	Effluent	Percent Difference	
O&M Report #2	3/9/2021	7.69	3.60	-53%	5.64	8.48	50%	94.6	136	44%	13.0	13.9	7%	8.03	1.61	-80%	0	0	0%	
	3/16/2021	6.10	2.39	-61%	5.30	7.43	40%	87.3	101	15%	12.5	12.5	0%	6.07	0.06	-99%	0	0	0%	
	3/17/2021	9.42	6.11	-35%	6.10	6.23	2%	75.5	77.5	3%	10.9	11.2	3%	41.2	0.32	-99%	0	0	0%	
	3/19/2021	9.55	9.11	-5%	4.89	5.88	20%	69.0	68.0	-1%	13.6	12.9	-5%	12.8	0.00	-100%	0	0	0%	
	3/23/2021	8.39	5.53	-34%	6.43	7.05	10%	77.3	88.4	14%	NM	NM	NM	12.0	0.52	-96%	0	0	0%	
	3/30/2021	5.92	3.50	-41%	6.41	7.27	13%	137	91.3	-34%	19.3	19.4	0%	67.7	1.73	-97%	0	0	0%	
	4/1/2021	8.28	7.77	-6%	7.12	7.71	8%	98.2	133	36%	18.7	18.9	1%	32.8	0.63	-98%	0	0	0%	
	4/12/2021	5.03	3.89	-23%	6.07	6.25	3%	94.8	114	20%	22.3	21.8	-3%	114	1.22	-99%	0	0	0%	
	4/15/2021	7.48	7.36	-2%	7.26	7.35	1%	117	120	2%	23.8	23.8	0%	71.7	2.58	-96%	0	0	0%	
	4/19/2021	7.00	6.80	-3%	5.97	7.07	18%	80.7	122	51%	11.9	12.6	6%	0.77	0.00	-100%	0	0	0%	
	4/27/2021	4.90	0.09	-98%	6.37	7.56	19%	104	428	314%	25.5	23.9	-6%	3.49	3.60	3%	0	0	0%	
	4/30/2021	4.71	1.97	-58%	5.25	6.55	25%	79.2	95.0	20%	23.1	23.0	0%	2.02	2.60	29%	0	0	0%	
		<i>Average</i>	<i>7.04</i>	<i>4.84</i>	<i>-31%</i>	<i>6.07</i>	<i>7.07</i>	<i>17%</i>	<i>93</i>	<i>131</i>	<i>41%</i>	<i>17.7</i>	<i>17.6</i>	<i>0%</i>	<i>31.0</i>	<i>1.2</i>	<i>-96%</i>	<i>0.0</i>	<i>0.0</i>	<i>0%</i>
		<i>Median</i>	<i>7.24</i>	<i>4.71</i>	<i>-35%</i>	<i>6.09</i>	<i>7.17</i>	<i>18%</i>	<i>91.0</i>	<i>107</i>	<i>18%</i>	<i>18.7</i>	<i>18.9</i>	<i>1%</i>	<i>12.4</i>	<i>0.93</i>	<i>-93%</i>	<i>0.0</i>	<i>0.0</i>	<i>0%</i>

Notes:

Average and median percent difference are calculated based on the average and median values of each parameter.

- DO dissolved oxygen
- mg/L milligram per liter
- SU standard units
- NTU nephelometric turbidity units
- uS/cm milliSiemens per centimeter
- TSS total suspended solids
- NM Not Measured

FIGURES

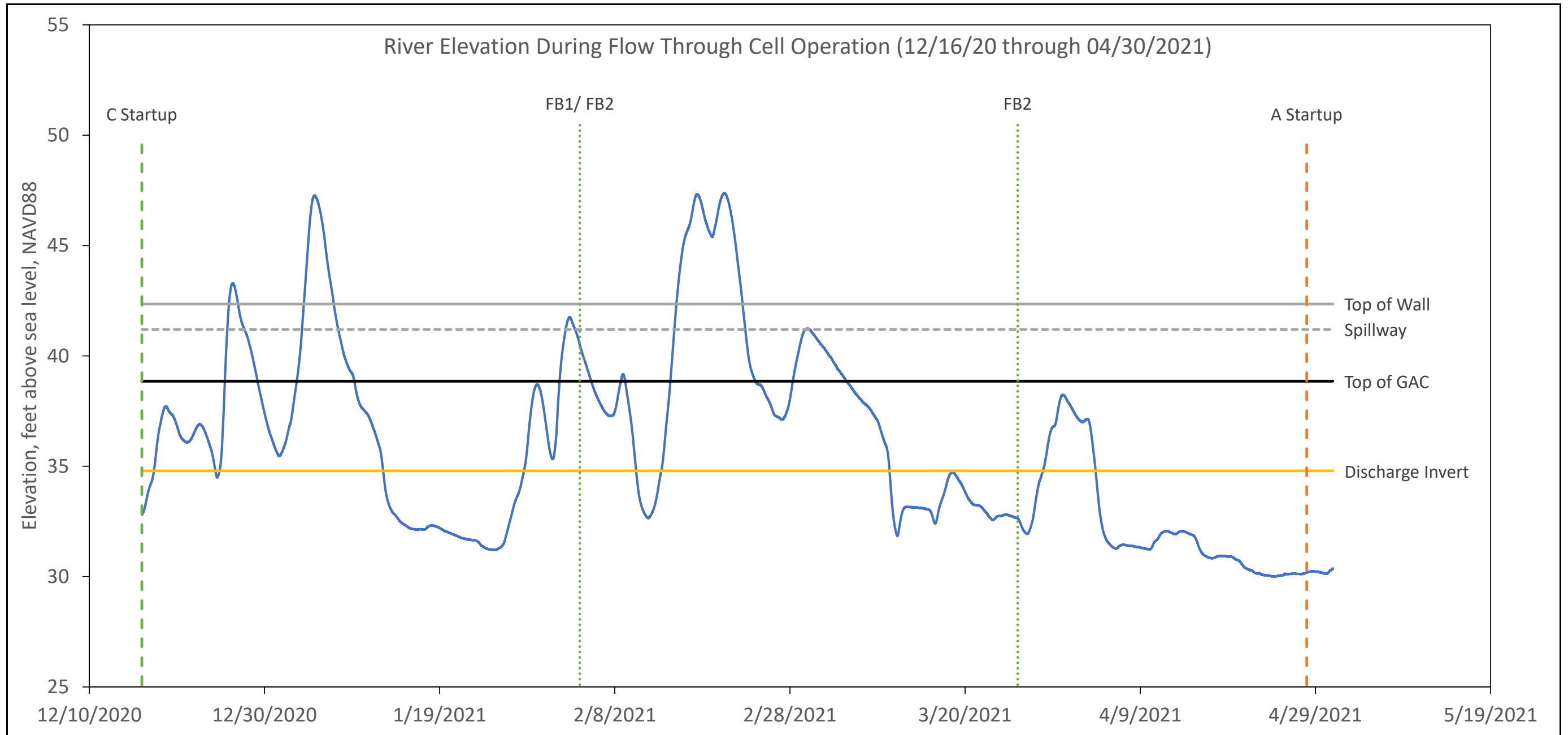

Legend
 — River
 ... GAC Changeout, Seep C

Notes:
 As-built survey information for Seep C from RMA Surveying October 2020.
 River elevation from USGS Huske Lock and Dam site 02105500, converted to NAVD88.
 For clarity of presentation, Figure 1 shows Seep C elevations only. Seep A equivalent features are approximately 1 foot lower in elevation.
 FB1/FB2 = Filter Bed 1/Filter Bed 2

River Level & Seep C FTC As-Built Elevations	
Chemours Fayetteville Works Fayetteville, North Carolina	
Geosyntec [®] consultants	Geosyntec Consultants of NC, P.C. NC License No.: C-3500 and C-295
Raleigh, NC	May 2021
Figure 1	

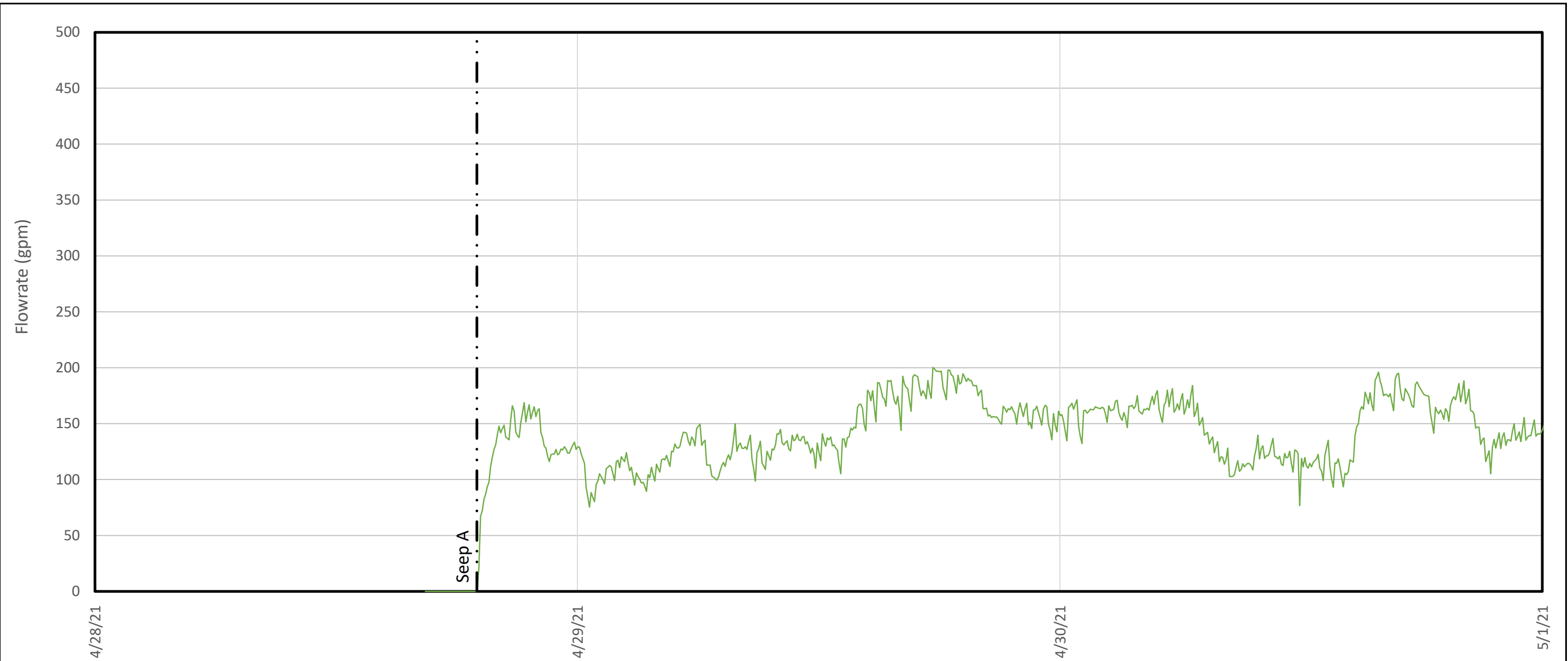

Legend
 — Measureable Discharge Flowrate

Flowrate Statistics (gpm)

	(04/27 - 04/30)	Since Startup
Median Q	142	142
95 th percentile Q	188	188
Max Q	200	200

Notes:
 Figure 2A depicts the measurable discharge flowrate calculated using the Discharge Basin transducer data (solid green). Seep A flowrates were calculated using design FTC elevations. A licensed survey of the key features will be performed in June 2021 and the calculations for future reports will be updated with as-built elevations.

Measured Discharge Flowrate - Seep A	
Chemours Fayetteville Works Fayetteville, North Carolina	
Geosyntec consultants	Geosyntec Consultants of NC, P.C. NC License No.: C 3500 and C 295
Raleigh, NC	May 2021
Figure 2A	

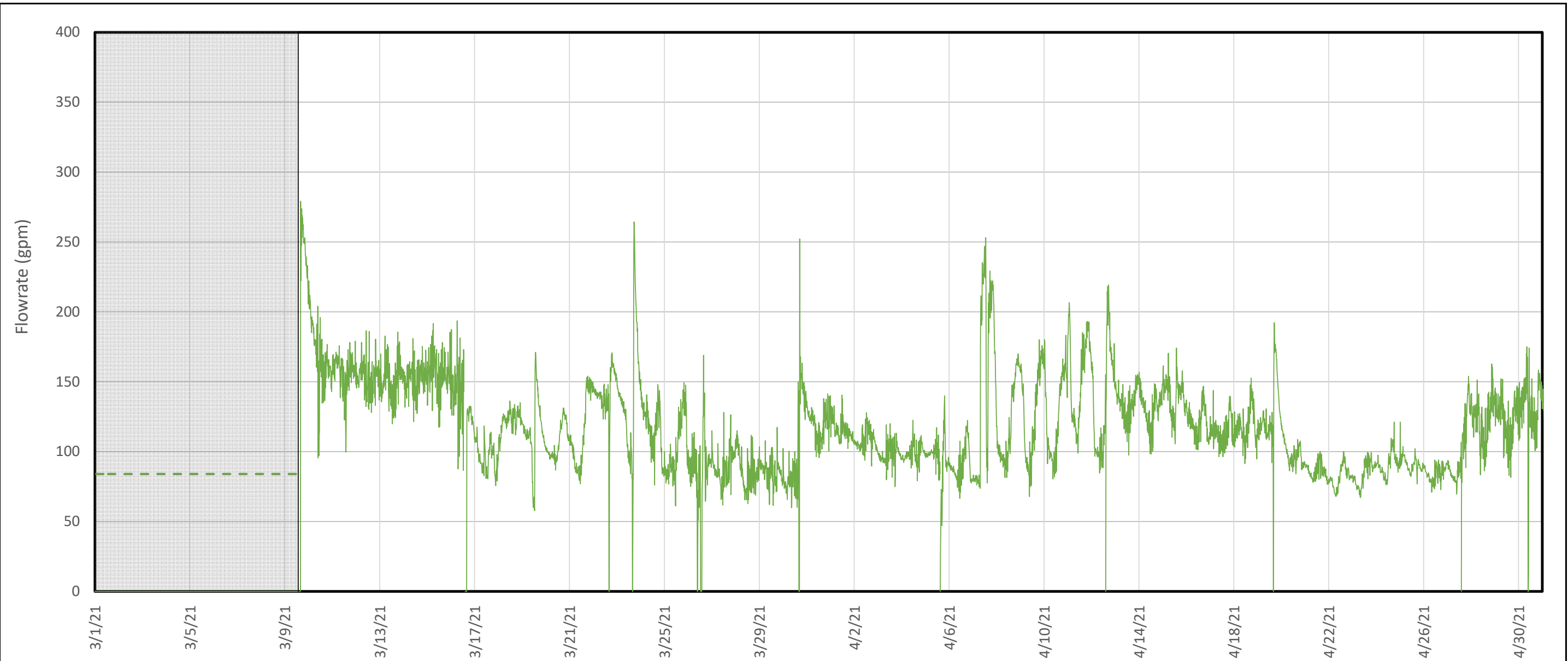

Flowrate Statistics (gpm)

	(03/01 - 04/30)	Since Startup
Median Q	113	106
95 th percentile Q	172	169
Max Q	279	279

Legend

- Measurable Discharge Flowrate
- - - Imputed Discharge Flowrate
- Transducer Data Gap

Notes:

Figure 2C depicts the measurable discharge flowrate calculated using the Discharge Basin transducer data (solid green). Where transducer data was missing but flow through the System was observed (i.e., non-flooding conditions), flowrate was extrapolated (dashed green). The extrapolation through 3/9/2021 utilized the median flowrate from the preceding dataset of measurable flowrates.

Gaps in the transducer data record (grey shading) are described in Section 3.

Measured and Imputed Discharge Flowrate - Seep C	
Chemours Fayetteville Works Fayetteville, North Carolina	
Geosyntec <small>consultants</small>	<small>Geosyntec Consultants of NC, P.C. NC License No.: C 3500 and C 295</small>
Raleigh, NC	May 2021
Figure 2C	

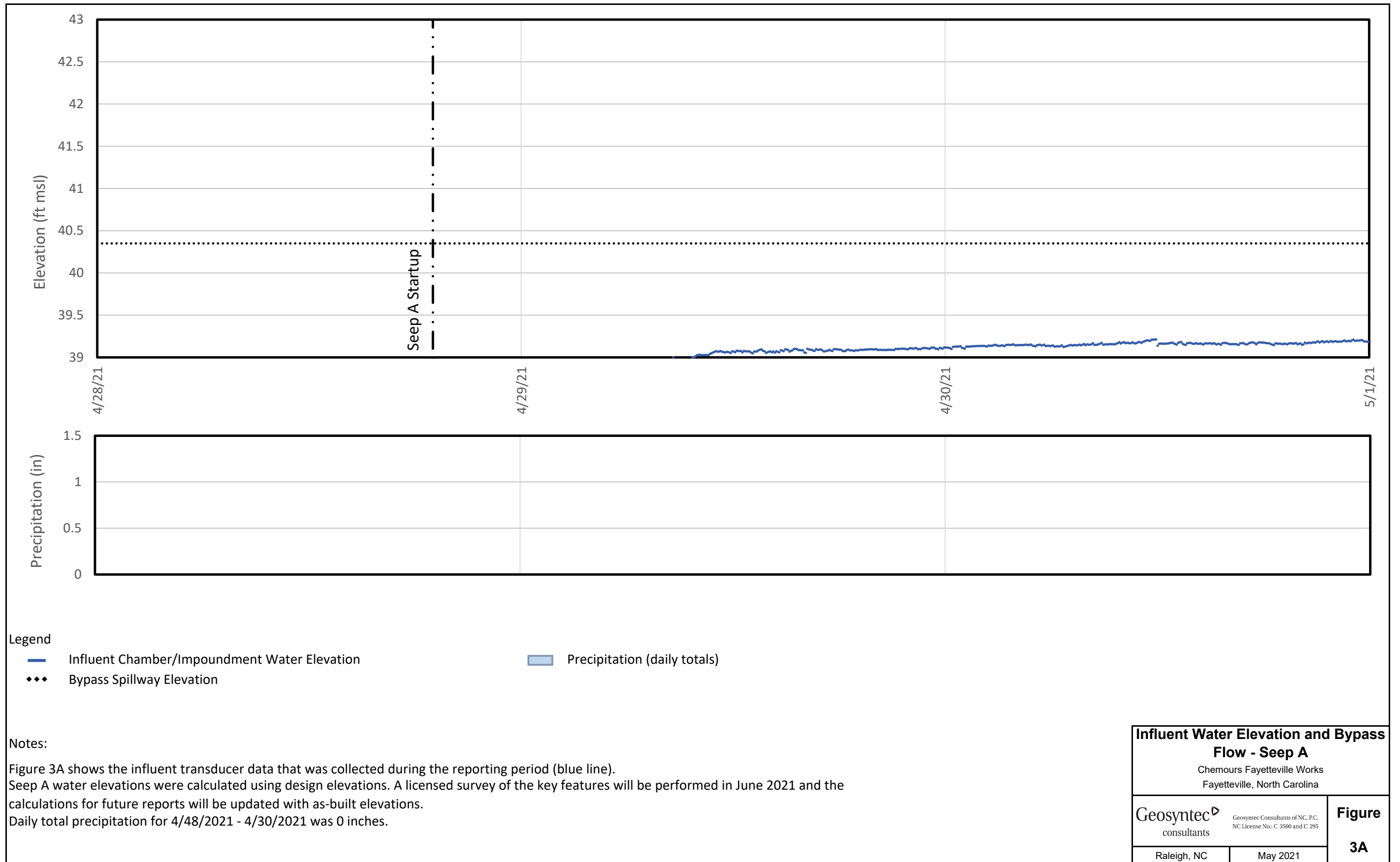

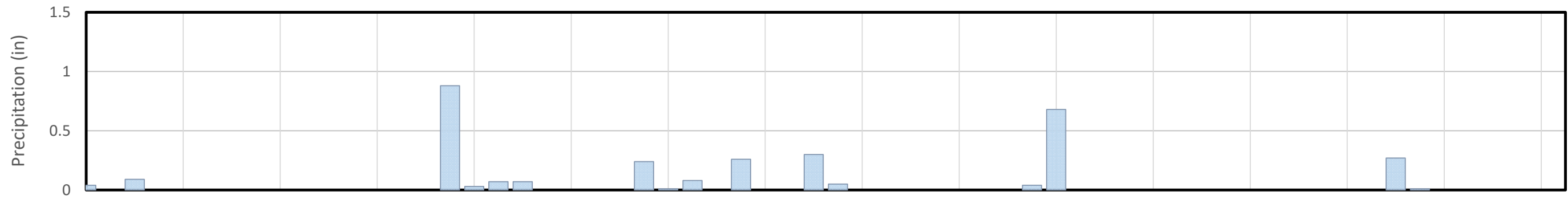
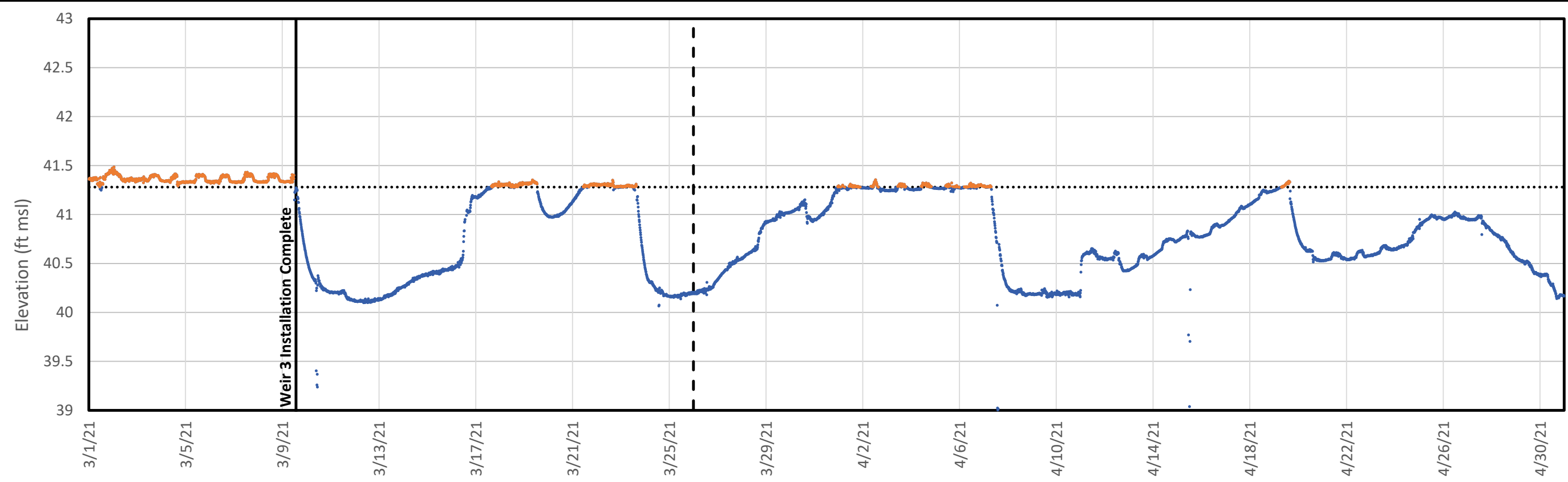

- Legend
- Influent Chamber/Impoundment Water Elevation
 - Impoundment Water Elevation Above Bypass Spillway
 - ◆◆◆ Bypass Spillway Elevation
 - Precipitation (daily totals)
 - - - GAC Changeout

Notes:
 Figure 3C shows the influent transducer data that was collected during the reporting period (blue line). Instances of impoundment bypass flow are shown in orange.

Influent Water Elevation and Bypass Flow - Seep C	
Chemours Fayetteville Works Fayetteville, North Carolina	
Geosyntec consultants	Geosyntec Consultants of NC, P.C. NC License No.: C 3500 and C 295
Raleigh, NC	May 2021

Figure 3C



Legend
 — Turbidity
 ■ Precipitation (daily totals)

Notes
 NTU - Nephelometric Turbidity Unit
 Turbidity data logged with a AquaTROLL Turbidity Sensor placed in the Influent Stilling Basin.
 The peak values recorded by the turbidity sensor (over 4,500 NTU) may be biased high, as the sensors can become clogged during high sediment-loading events. The interpretation of the turbidity data in the report is largely derived on the timing of the readings (i.e., baseline dry weather turbidity is very low and spikes after rain events). For clarity, the y-axis above is limited to 500 NTU.

Seep C Turbidity Logging and Precipitation (Mar - Apr 2021)		Figure 4
Chemours Fayetteville Works Fayetteville, North Carolina		
Geosyntec [®] consultants	<small>Geosyntec Consultants of NC, P.C. NC License No.: C 3500 and C 295</small>	
Raleigh, NC	May 2021	

APPENDIX A

Seep A Process Flow Diagram (Drawing D-01)

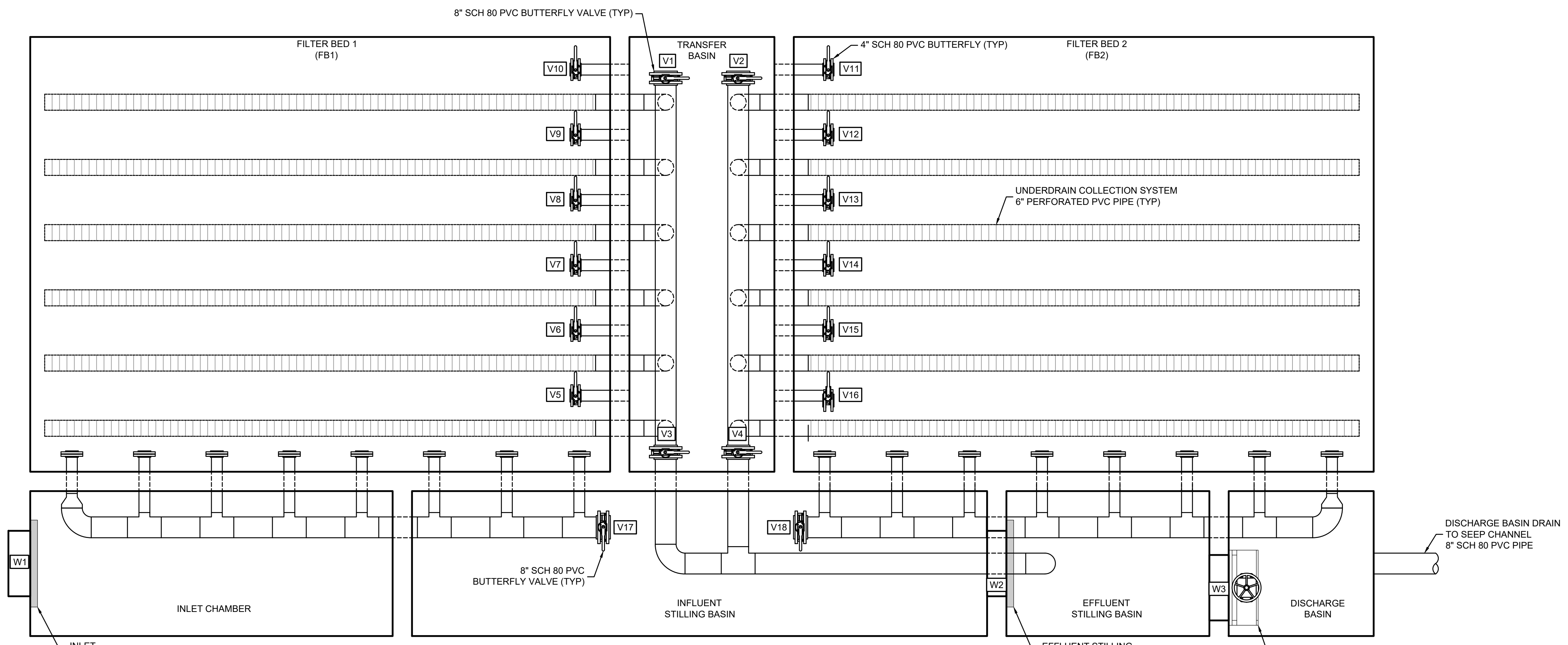

13 PLAN
D-01 FILTER BED VALVE SCHEMATIC

OPERATIONAL MODE				
FLOW CONTROL DEVICE	FB1 LEAD/FB2 LAG	FB1 LAG/FB2 LEAD	FB1 CHANGEOUT (FB2 OPEN)	FB2 CHANGEOUT (FB1 OPEN)
VALVE V1	OPEN	CLOSED	CLOSED	CLOSED
VALVE V2	CLOSED	OPEN	CLOSED	CLOSED
VALVE V3	CLOSED	OPEN	CLOSED	OPEN
VALVE V4	OPEN	CLOSED	OPEN	CLOSED
VALVE V5	CLOSED	OPEN	CLOSED	CLOSED
VALVE V6	CLOSED	OPEN	CLOSED	CLOSED
VALVE V7	CLOSED	OPEN	CLOSED	CLOSED
VALVE V8	CLOSED	OPEN	CLOSED	CLOSED
VALVE V9	CLOSED	OPEN	CLOSED	CLOSED
VALVE V10	CLOSED	OPEN	CLOSED	CLOSED
VALVE V11	OPEN	CLOSED	CLOSED	CLOSED
VALVE V12	OPEN	CLOSED	CLOSED	CLOSED
VALVE V13	OPEN	CLOSED	CLOSED	CLOSED
VALVE V14	OPEN	CLOSED	CLOSED	CLOSED
VALVE V15	OPEN	CLOSED	CLOSED	CLOSED
VALVE V16	OPEN	CLOSED	CLOSED	CLOSED
VALVE V17	OPEN	CLOSED	CLOSED	OPEN
VALVE V18	CLOSED	OPEN	OPEN	CLOSED
WEIR W1	OPEN	OPEN	OPEN	OPEN
WEIR W2	OPEN	OPEN	OPEN	OPEN
WEIR W3	OPEN	OPEN	OPEN	OPEN

14 TABLE
D-01 OPERATIONAL MODE

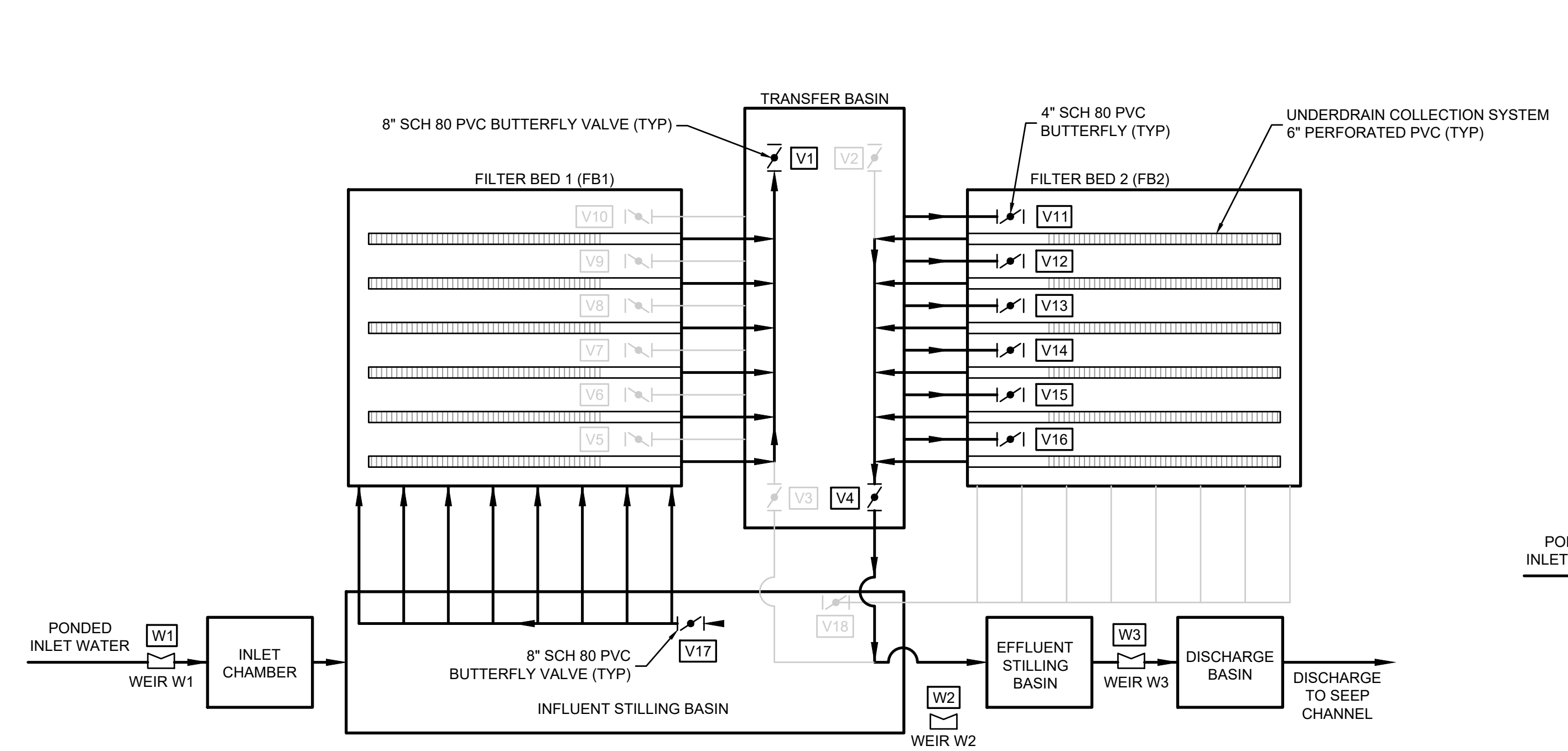

15 SCHEMATIC
D-01 FILTER BED SYSTEM FLOW WITH CARBON BED 1 IN LEAD POSITION AND CARBON BED 2 IN LAG POSITION

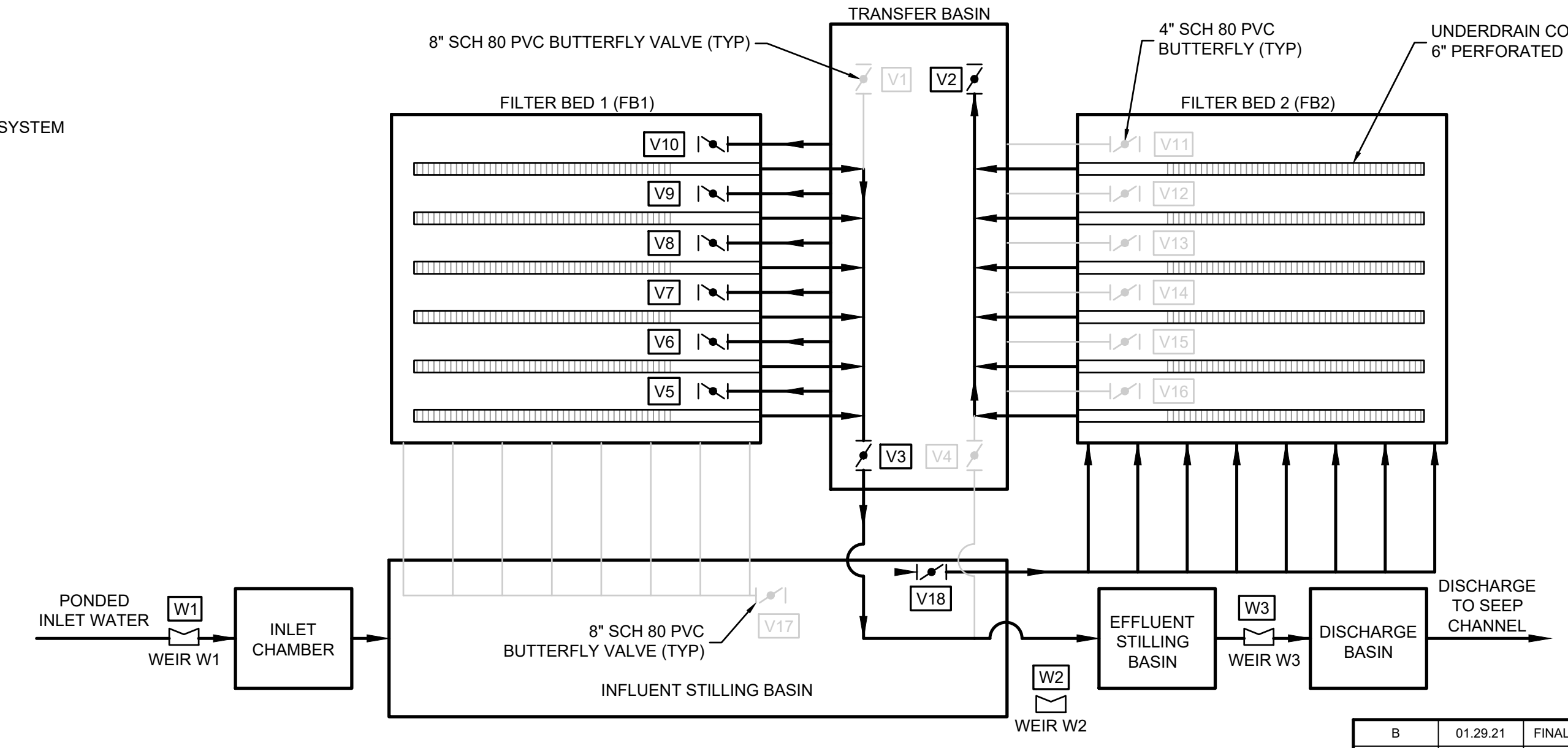

16 SCHEMATIC
D-01 FILTER BED SYSTEM FLOW WITH CARBON BED 2 IN LEAD POSITION AND CARBON BED 1 IN LAG POSITION

- NOTES:
- CONTRACTOR TO PROVIDE VALVE TAGS THAT MATCH IDENTIFICATIONS ABOVE.
 - VALVE HANDLES SHALL BE POSITIONED SUCH THAT THEY ARE PERPENDICULAR TO DIRECTION OF PIPE WHEN CLOSED, AND PARALLEL TO DIRECTION OF PIPE WHEN OPENED.

B	01.29.21	FINAL 100% ISSUED FOR CONSTRUCTION SUBMITTAL	JFH	CAS
A	10.30.20	DRAFT 100% ISSUED FOR CONSTRUCTION SUBMITTAL	JFH	CAS
REV	DATE	DESCRIPTION	DRN	APP

Geosyntec consultants
Geosyntec Consultants of NC, P.C.
NC License No.: C-3500 and C-295

ATRUM AT BLUE RIDGE
2501 BLUE RIDGE ROAD, SUITE 430
RALEIGH, NC 27607
919.870.0576

TITLE: SEEPS A, B, AND D INTERIM REMEDIATION SYSTEM PROCESS FLOW DIAGRAM
PROJECT: THE CHEMOURS COMPANY SEEPS A, B, AND D INTERIM REMEDIATION SYSTEM
SITE: FAYETTEVILLE WORKS SITE

DESIGN BY: CMDS DATE: JANUARY 2021
DRAWN BY: JFH PROJECT NO.: TR0795
CHECKED BY: JWE FILE: TR0795-D01.dwg
REVIEWED BY: JJD DRAWING NO.:
APPROVED BY: CAS D-01

100% DESIGN DRAWINGS - ISSUED FOR CONSTRUCTION
401 CERTIFICATION #WQC004235 (12/16/2020) AND
USACE 404 PERMIT SAW-2019-00206 (12/18/2020)

DATE: _____
SIGNATURE: *James J. Deitch*
SEAL: NORTH CAROLINA PROFESSIONAL ENGINEER JAMES J. DEITCH 040550

VEN:CAD/CADD/CADD/CHEMOURS/INTERIM SEEP REMEDIATION SEEPS A & B/CONSTRUCTION AND DRAWING/170795-001

APPENDIX B

Transducer Data Reduction

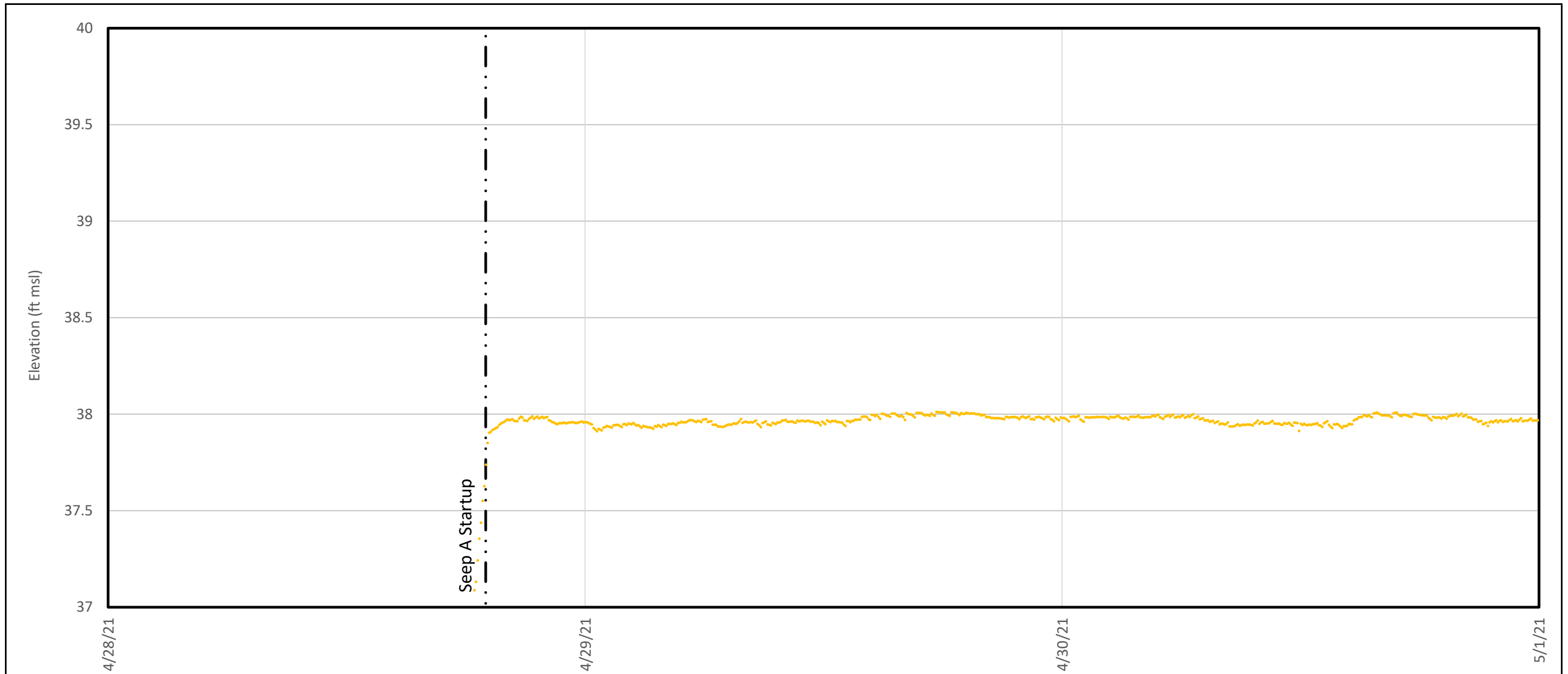

Legend

— Discharge Basin Elevation

Note:

Figure B1-A shows the discharge basin transducer data that was collected during the reporting period.

Discharge Basin Water Elevation - Seep A	
Chemours Fayetteville Works Fayetteville, North Carolina	
Geosyntec [®] consultants	<small>Geosyntec Consultants of NC, P.C. NC License No.: C 3500 and C 295</small>
Raleigh, NC	May 2021
Figure B1-A	

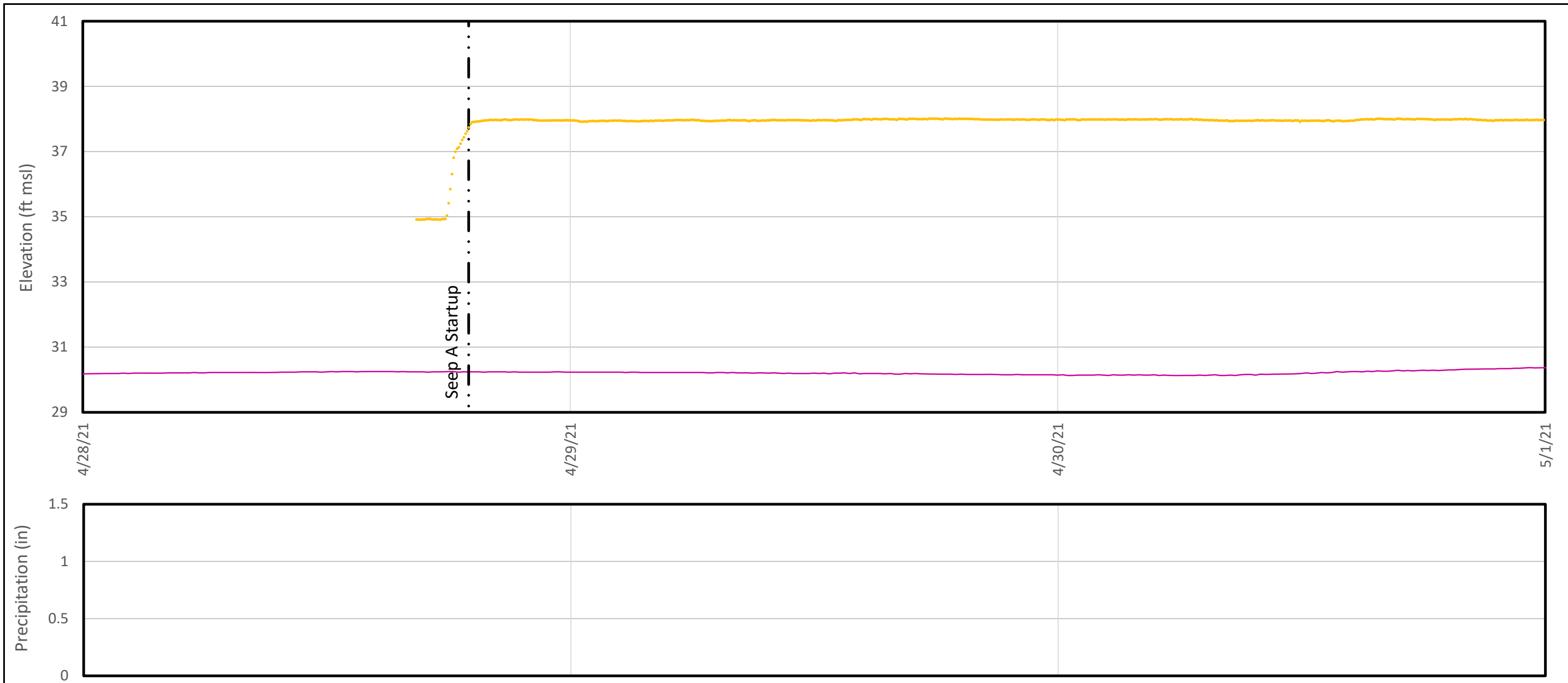

- Legend**
- Discharge Basin Water Elevation
 - River Stage
 - Precipitation (daily totals)

Notes:
 As water can flow through the flow-through cell both as a result of wet weather inflow and elevated river levels from flooding, Figure B2-A compares the available transducer data to precipitation and river stage elevation data available from the USGS Huske Lock and Dam. Discharge Basin transducer data that was affected by river flooding is excluded from the dataset, to evaluate only effluent flow measurements that are from the flow-through cell. Daily total precipitation for 4/48/2021 - 4/30/2021 was 0 inches.

Discharge Basin Water Elevation and External Forcings - Seep A	
Chemours Fayetteville Works Fayetteville, North Carolina	
Geosyntec <small>consultants</small>	<small>Geosyntec Consultants of NC, P.C. NC License No: C 3500 and C 295</small>
Raleigh, NC	May 2021
Figure B2-A	

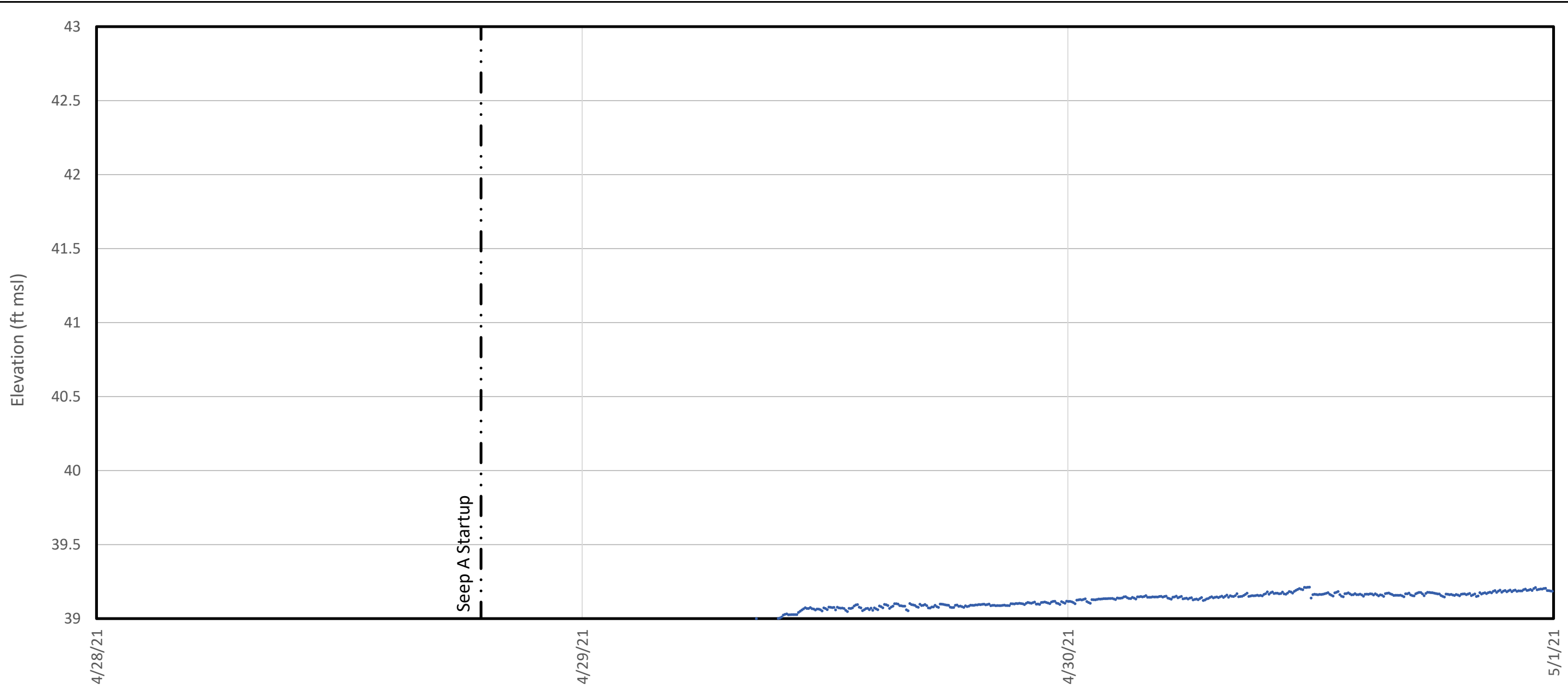

Legend

— Inlet Chamber/Impoundment Elevation

Note:

Figure B3-A shows the influent transducer data that was collected during the reporting period.

Inlet Chamber Water Elevation - Seep A Chemours Fayetteville Works Fayetteville, North Carolina	
Geosyntec [®] consultants	<small>Geosyntec Consultants of NC, P.C. NC License No.: C 3500 and C 295</small>
Raleigh, NC	May 2021

**Figure
B3-A**

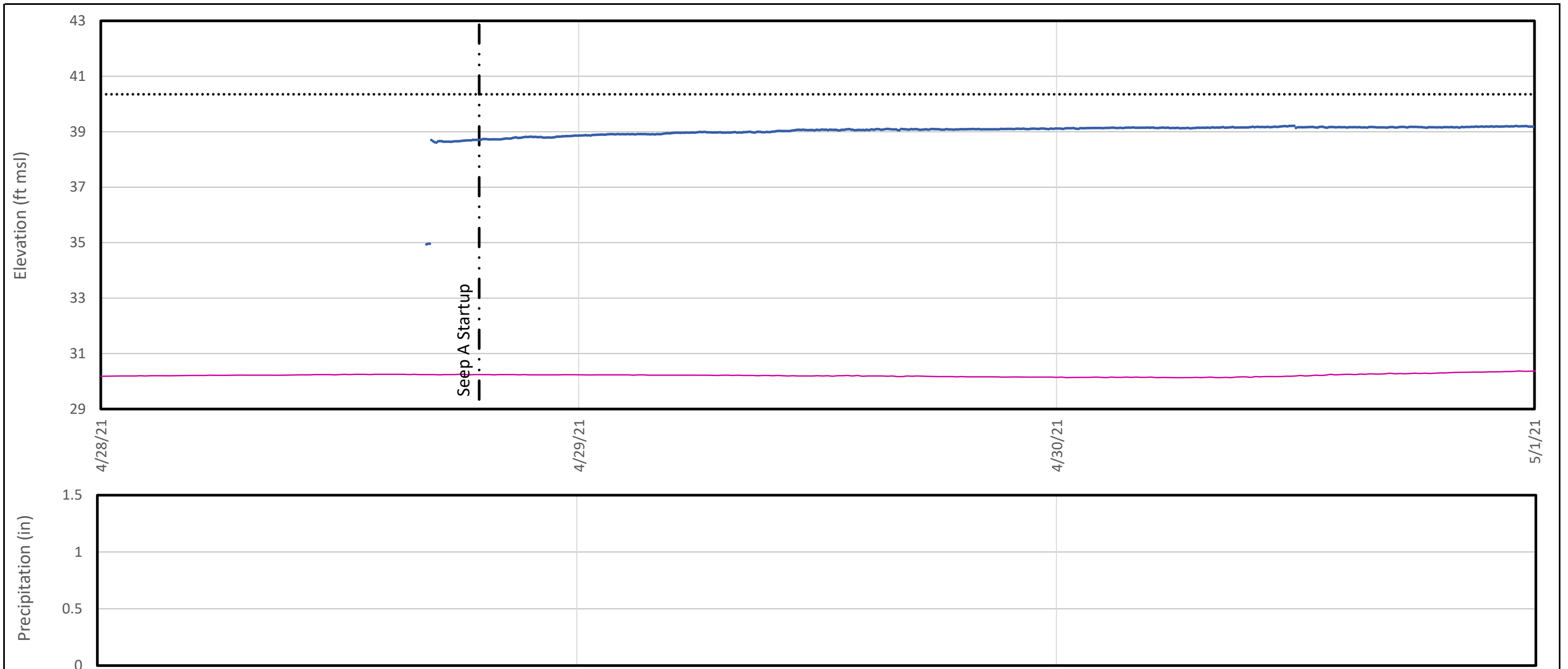

Legend

- Inlet Chamber Water Elevation
- River Stage
- ◆◆◆ Bypass Spillway Elevation
- Precipitation (daily totals)

Notes:

As water can flow through the Bypass Spillway both as a result of wet weather inflow and elevated river levels from flooding, Figure B4-A compares the available transducer data to precipitation and river stage elevation data available from the USGS Huske Lock and Dam.

Daily total precipitation for 4/48/2021 - 4/30/2021 was 0 inches.

Inlet Chamber Water Elevation and External Forcings - Seep A	
Chemours Fayetteville Works Fayetteville, North Carolina	
Geosyntec [®] consultants	Geosyntec Consultants of NC, P.C. NC License No.: C 3500 and C 295
Raleigh, NC	May 2021
Figure B4-A	

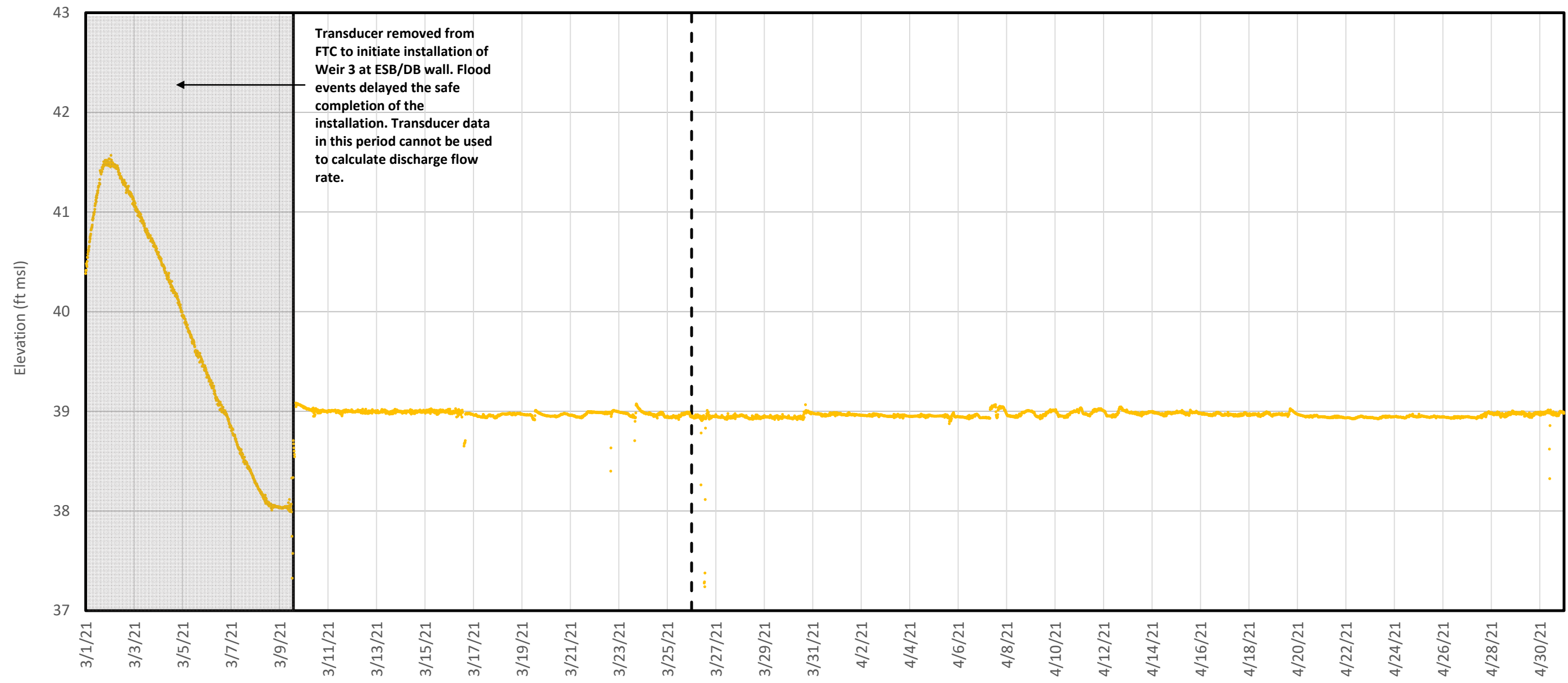

Legend

- Discharge Basin Elevation
- Transducer Data Gap
- GAC Changeout

Note:
 Figure B1-C shows the discharge basin transducer data that was collected during the reporting period. Gaps in the data record are shown (grey shading) and described above.

Discharge Basin Water Elevation - Seep C	
Chemours Fayetteville Works Fayetteville, North Carolina	
Geosyntec consultants	<small>Geosyntec Consultants of NC, P.C. NC License No.: C 3500 and C 295</small>
Raleigh, NC	May 2021
Figure B1-C	

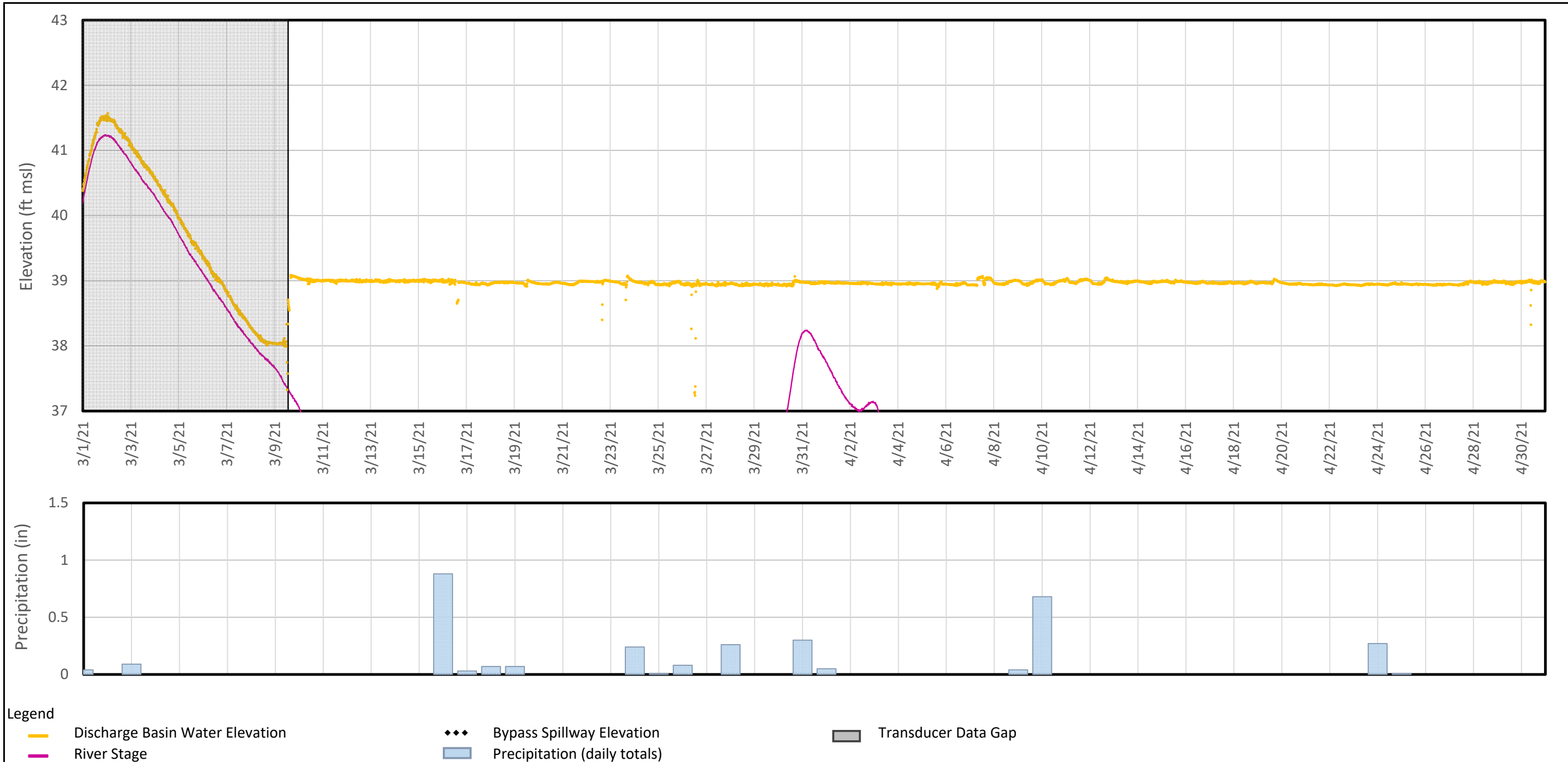

Notes:

As water can flow through the flow-through cell both as a result of wet weather inflow and elevated river levels from flooding, Figure B2-C compares the available transducer data to precipitation and river stage elevation data available from the USGS Huske Lock and Dam.

Discharge Basin Water Elevation and External Forcings - Seep C Chemours Fayetteville Works Fayetteville, North Carolina		Figure B2-C
Geosyntec [®] consultants <small>Geosyntec Consultants of NC, P.C. NC License No.: C 3500 and C 295</small>		
Raleigh, NC	May 2021	

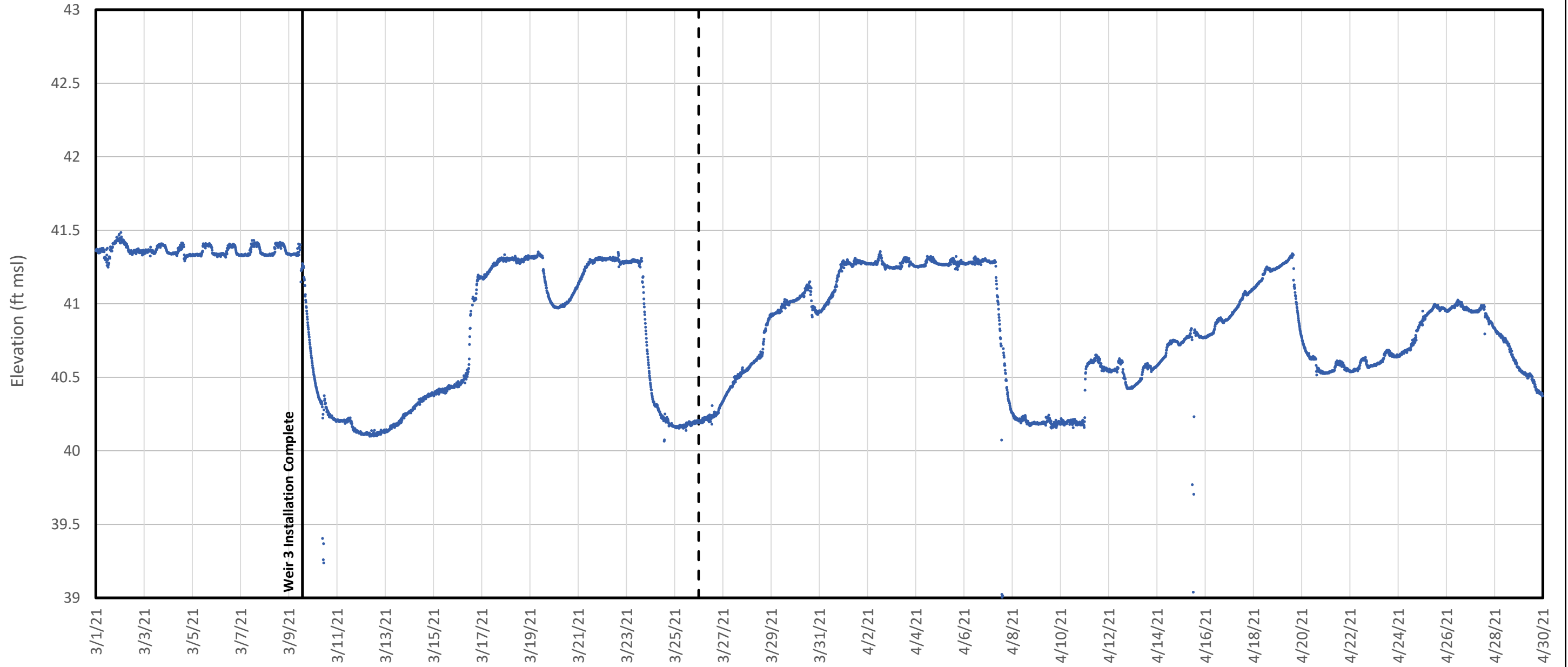

Legend

- Influent Chamber/Impoundment Elevation
- GAC Changeout

Note:

Figure B3-C shows the influent transducer data that was collected during the reporting period.

Inlet Chamber Water Elevation - Seep C		Figure B3-C
Chemours Fayetteville Works Fayetteville, North Carolina		
Geosyntec [®] consultants	Geosyntec Consultants of NC, P.C. NC License No.: C 3500 and C 295	
Raleigh, NC	May 2021	

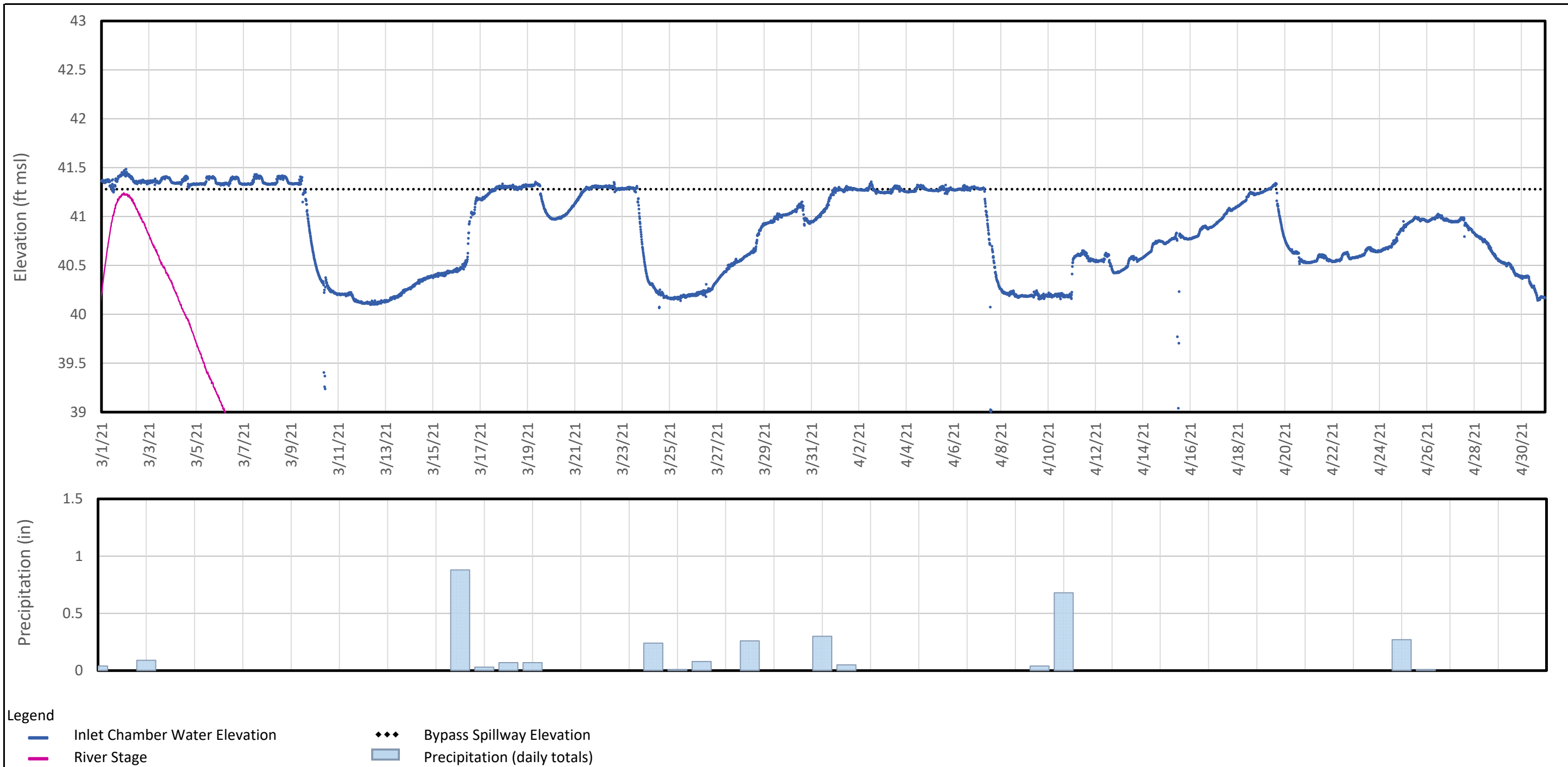

Notes:

As water can flow through the Bypass Spillway both as a result of wet weather inflow and elevated river levels from flooding, Figure B4-C compares the available transducer data to precipitation and river stage elevation data available from the USGS Huske Lock and Dam.

Inlet Chamber Water Elevation and External Forcings - Seep C Chemours Fayetteville Works Fayetteville, North Carolina		Figure B4-C
Geosyntec [®] consultants	<small>Geosyntec Consultants of NC, P.C. NC License No.: C 3500 and C 295</small>	
Raleigh, NC	May 2021	

APPENDIX C
Laboratory Analytical Data Review Narrative
(Full lab reports to be uploaded to OneDrive and EQUIS)

ADQM Data Review

Site: Chemours Fayetteville

Project: Seep Flow Through Cell Sampling 2021 (select lots)

Project Reviewer: Michael Aucoin

Sample Summary

Field Sample ID	Lab Sample ID	Sample Matrix	Filtered	Sample Date	Sample Time	Sample Purpose
SEEP-C-RAIN-INFLUENT-24-031721	320-71576-1	Other liquid	N	03/17/2021	11:42	FS
SEEP-C-RAIN-EFFLUENT-24-031721	320-71576-2	Other liquid	N	03/17/2021	11:42	FS
SEEP-C-RAIN-EQBLK-031721	320-71576-3	Blank Water	N	03/17/2021	10:00	EB
SEEP-C-EFFLUENT-336-031921	320-71576-4	Other liquid	N	03/19/2021	09:00	FS
SEEP-C-INFLUENT-336-031921	320-71576-5	Other liquid	N	03/19/2021	09:00	FS
SEEP-C-FBLK-336-031921	320-71576-6	Blank Water	N	03/19/2021	08:00	FB
SEEP-C-EFFLUENT-300-033121	320-72353-1	Other liquid	N	03/31/2021	18:00	FS
SEEP-C-INFLUENT-300-033121	320-72353-2	Other liquid	N	03/31/2021	18:00	FS
SEEP-C-FBLK-300-033121	320-72353-3	Blank Water	N	03/31/2021	15:00	FB
SEEP-C-EFFLUENT-300-033121-D	320-72353-4	Other liquid	N	03/31/2021	18:00	DUP
SEEP-C-effluent-336-041521	320-72555-1	Other liquid	N	04/15/2021	08:20	FS
SEEP-C-effluent-336-041521-D	320-72555-2	Other liquid	N	04/15/2021	08:20	DUP
SEEP-C-influent-336-041521	320-72555-3	Other liquid	N	04/15/2021	08:20	FS
SEEP-C-FBLK-041621	320-72555-4	Blank Water	N	04/16/2021	10:00	FB
SEEP-C-EQBLK-041621	320-72555-5	Blank Water	N	04/16/2021	10:05	EB

* FS=Field Sample
 DUP=Field Duplicate
 FB=Field Blank
 EB=Equipment Blank
 TB=Trip Blank

Analytical Protocol

Laboratory	Method	Parameters
TAL – Sacramento	Cl. Spec. Table 3 Compound SOP	20 compounds incl HFPO-DA

ADQM Data Review Checklist

Item	Description	Yes	No*	DVM Narrative Report	Laboratory Report	Exception Report (ER) #
A	Did samples meet laboratory acceptability requirements upon receipt (i.e., intact, within temperature, properly preserved, and no headspace where applicable)?	X				
B	Were samples received by the laboratory in agreement with the associated chain of custody?	X				
C	Was the chain of custody properly completed by the laboratory and/or field team?	X				
D	Were samples prepped/analyzed by the laboratory within method holding times?	X				
E	Were QA/QC criteria met by the laboratory (method blanks, LCSs/LCSDs, MSs/MSDs, PDSs, SDs, duplicates/replicates, surrogates, total/dissolved differences/RPDs, sample results within calibration range)?		X	X		
F	Were field/equipment/trip blanks (if collected) detected at levels not requiring sample data qualification?	X				
G	Were all data usable and not R qualified?	X				
ER#	Description					
Other QA/QC Items to Note:						

* See DVM Narrative Report, Lab Report, or ER # for further details as indicated.

The electronic data submitted for this project was reviewed via the Data Verification Module (DVM) process. Overall, the data is acceptable for use without qualification, except as noted on the attached DVM Narrative Report.

The lab reports due to a large page count are stored on a network shared drive and are available to be posted on external shared drives, or on a flash drive.

Data Verification Module (DVM)

The DVM is an internal review process used by the ADQM group to assist with the determination of data usability. The electronic data deliverables received from the laboratory are loaded into the Locus EIM™ database and processed through a series of data quality checks, which are a combination of software (Locus EIM™ database Data Verification Module (DVM)) and manual reviewer evaluations. The data is evaluated against the following data usability checks:

- Field and laboratory blank contamination
- US EPA hold time criteria
- Missing Quality Control (QC) samples
- Matrix spike (MS)/matrix spike duplicate (MSD) recoveries and the relative percent differences (RPDs) between these spikes
- Laboratory control sample (LCS)/laboratory control sample duplicate (LCSD) recoveries and the RPD between these spikes
- Surrogate spike recoveries for organic analyses
- Difference/RPD between field duplicate sample pairs
- RPD between laboratory replicates for inorganic analyses
- Difference/percent difference between total and dissolved sample pairs

There are two qualifier fields in EIM:

Lab Qualifier is the qualifier assigned by the lab and may not reflect the usability of the data. This qualifier may have many different meanings and can vary between labs and over time within the same lab. Please refer to the laboratory report for a description of the lab qualifiers. As they are lab descriptors they are not to be used when evaluating the data.

Validation Qualifier is the 3rd party formal validation qualifier if this was performed. Otherwise this field contains the qualifier resulting from the ADQM DVM review process. This qualifier assesses the usability of the data and may not equal the lab qualifier. The DVM applies the following data evaluation qualifiers to analysis results, as warranted:

Qualifier	Definition
B	Not detected substantially above the level reported in the laboratory or field blanks.
R	Unusable result. Analyte may or may not be present in the sample.
J	Analyte present. Reported value may not be accurate or precise.
UJ	Not detected. Reporting limit may not be accurate or precise.

The **Validation Status Code** field is set to "DVM" if the ADQM DVM process has been performed. If the DVM has not been run, the field will be blank.

If the DVM has been run (**Validation Status Code** equals "DVM"), use the **Validation Qualifier**.

If the data has been validated by a third party, the field "**Validated By**" will be set to the validator (e.g., ESI for Environmental Standards, Inc.).

DVM Narrative Report

Site: Fayetteville

Sampling Program: Seep Flow Through Cell Sampling 2021

Validation Options: LABSTATS

Validation Reason

Associated LCS and/or LCSD analysis had relative percent recovery (RPR) values less than the lower control limit but above 10%. The actual detection limits may be higher than reported.

Field Sample ID	Date Sampled	Lab Sample ID	Analyte	Result	Units	Type	MDL	PQL	Validation Qualifier	Analytical Method	Pre-prep	Prep
SEEP-C-effluent-336-041521	04/15/2021	320-72555-1	PFECA-G	0.0020	UG/L	PQL		0.0020	UJ	Cl. Spec. Table 3 Compound SOP		PFAS_DI_Prep
SEEP-C-effluent-336-041521	04/15/2021	320-72555-1	PFECA-G	0.0020	UG/L	PQL		0.0020	UJ	Cl. Spec. Table 3 Compound SOP		PFAS_DI_Prep
SEEP-C-effluent-336-041521-D	04/15/2021	320-72555-2	PFECA-G	0.0020	UG/L	PQL		0.0020	UJ	Cl. Spec. Table 3 Compound SOP		PFAS_DI_Prep
SEEP-C-EQBLK-041621	04/16/2021	320-72555-5	PFECA-G	0.0020	UG/L	PQL		0.0020	UJ	Cl. Spec. Table 3 Compound SOP		PFAS_DI_Prep
SEEP-C-FBLK-041621	04/16/2021	320-72555-4	PFECA-G	0.0020	UG/L	PQL		0.0020	UJ	Cl. Spec. Table 3 Compound SOP		PFAS_DI_Prep
SEEP-C-influent-336-041521	04/15/2021	320-72555-3	PFECA-G	0.048	UG/L	PQL		0.048	UJ	Cl. Spec. Table 3 Compound SOP		PFAS_DI_Prep

Site: Fayetteville

Sampling Program: Seep Flow Through Cell Sampling 2021

Validation Options: LABSTATS

Validation Reason

High relative percent difference (RPD) observed between field duplicate and parent sample. The reported result may be imprecise.

Field Sample ID	Date Sampled	Lab Sample ID	Analyte	Result	Units	Type	MDL	PQL	Validation Qualifier	Analytical Method	Pre-prep	Prep
SEEP-C-EFFLUENT-300-033121	03/31/2021	320-72353-1	PFO2HxA	0.0092	ug/L	PQL		0.0020	J	Cl. Spec. Table 3 Compound SOP		PFAS_DI_Prep
SEEP-C-EFFLUENT-300-033121	03/31/2021	320-72353-1	PFO2HxA	0.0092	ug/L	PQL		0.0020	J	Cl. Spec. Table 3 Compound SOP		PFAS_DI_Prep
SEEP-C-EFFLUENT-300-033121-D	03/31/2021	320-72353-4	PFO2HxA	0.013	ug/L	PQL		0.0020	J	Cl. Spec. Table 3 Compound SOP		PFAS_DI_Prep

Site: Fayetteville

Sampling Program: Seep Flow Through Cell Sampling 2021

Validation Options: LABSTATS

Validation Reason

Associated MS and/or MSD analysis had relative percent recovery (RPR) values less than the lower control limit but above the rejection limit. The reported result may be biased low.

Field Sample ID	Date Sampled	Lab Sample ID	Analyte	Result	Units	Type	MDL	PQL	Validation Qualifier	Analytical Method	Pre-prep	Prep
SEEP-C-effluent-336-041521	04/15/2021	320-72555-1	PFMOAA	0.048	ug/L	PQL		0.0020	J	Cl. Spec. Table 3 Compound SOP		PFAS_DI_Prep
SEEP-C-effluent-336-041521	04/15/2021	320-72555-1	PFMOAA	0.050	ug/L	PQL		0.0020	J	Cl. Spec. Table 3 Compound SOP		PFAS_DI_Prep